



OPERATING INSTRUCTIONS

R-772
Audio/Video Receiver

SAFETY INSTRUCTIONS

- 1. Read Instructions** - All the safety and operating instructions should be read before the product is operated.
- 2. Retain instructions** - The safety and operating instructions should be retained for future reference.
- 3. Heed Warnings** - All warnings on the product and in the operating instructions should be adhered to.
- 4. Follow Instructions** - All operating and use instructions should be followed.
- 5. Cleaning** - Unplug this product from the wall outlet before cleaning. Do not use liquid cleaners or aerosol cleaners. Use a damp cloth for cleaning.
- 6. Attachments** - Do not use attachments not recommended by the product manufacturer as they may cause hazards.
- 7. Water and Moisture** - Do not use this product near water - for example, near a bath tub, wash bowl, kitchen sink, or laundry tub; in a wet basement, or near a swimming pool; and the like.
- 8. Accessories** - Do not place this product on an unstable cart, stand, tripod, bracket, or table. The product may fall, causing serious injury to a child or adult, and serious damage to the product. Use only with a cart, stand, tripod, bracket, or table recommended by the manufacturer, or sold with the product. Any mounting of the product should follow the manufacturer's instructions, and should use a mounting accessory recommended by the manufacturer.
- A product and cart combination should be moved with care. Quick stops, excessive force, and uneven surfaces may cause the product and cart combination to overturn.
- 10. Ventilation** - Slots and openings in the cabinet are provided for ventilation and to ensure reliable operation of the product and to protect it from overheating, and these openings must not be blocked or covered. The openings should never be blocked by placing the product on a bed, sofa, rug, or other similar surface. This product should not be placed in a built-in installation such as a bookcase or rack unless proper ventilation is provided or the manufacturer's instructions have been adhered to.
- 11. Power Sources** - This product should be operated only from the type of power source indicated on the marking label. If you are not sure of the type of power supply to your home, consult your product dealer or local power company. For products intended to operate from battery power, or other sources, refer to the operating instructions.
- 12. Grounding or Polarization** - This product may be equipped with a polarized alternating-current line plug (a plug having one blade wider than the other). This plug will fit into the power outlet only one way. This is a safety feature. If you are unable to insert the plug fully into the outlet, try reversing the plug. If the plug should still fail to fit, contact your electrician to replace your obsolete outlet. Do not defeat the safety purpose of the polarized plug.
Alternate Warnings - This product is equipped with a three-wire grounding-type plug, a plug having a third (grounding) pin. This plug will only fit into a grounding-type power outlet. This is a safety feature. If you are unable to insert the plug into the outlet, contact your electrician to replace your obsolete outlet. Do not defeat the safety purpose of the grounding-type plug.
- 13. Power-Cord Protection** - Power-supply cords should be routed so that they are not likely to be walked on or pinched by items placed upon or against them, paying particular attention to cords at plugs, convenience receptacles, and the point where they exit from the product.
- 14. Outdoor Antenna Grounding** - If an outside antenna or cable system is connected to the product, be sure the antenna or cable system is grounded so as to provide some protection against voltage surges and built-up static charges. Article 810 of the National Electrical Code, ANSI/NFPA 70, provides information with regard to proper grounding of the mast and supporting structure, grounding of the lead-in wire to an antenna discharge unit, size of



PORTABLE CART WARNING

grounding conductors, location of antenna-discharge unit, connection to grounding electrodes, and requirements for the grounding electrode. See Figure 1.

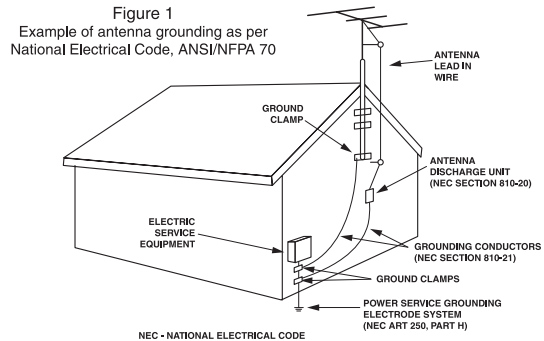



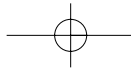

- 15. Lightning** - For added protection for this product during a lightning storm, or when it is left unattended and unused for long periods of time, unplug it from the wall outlet and disconnect the antenna or cable system. This will prevent damage to the product due to lightning and power-line surges.
- 16. Power Lines** - An outside antenna system should not be located in the vicinity of overhead power lines or other electric light or power circuits, or where it can fall into such power lines or circuits. When installing an outside antenna system, extreme care should be taken to keep from touching such power lines or circuits as contact with them might be fatal.
- 17. Overloading** - Do not overload wall outlets, extension cords, or integral convenience receptacles as this can result in a risk of fire or electric shock.
- 18. Object and Liquid Entry** - Never push objects of any kind into this product through openings as they may touch dangerous voltage points or short-out parts that could result in a fire or electric shock. Never spill liquid of any kind on the product.
- 19. Servicing** - Do not attempt to service this product yourself as opening or removing covers may expose you to dangerous voltage or other hazards. Refer all servicing to qualified service personnel.
- 20. Damage Requiring Service** - Unplug this product from the wall outlet and refer servicing to qualified service personnel under the following conditions:
 - When the power-supply cord or plug is damaged,
 - If liquid has been spilled, or objects have fallen into the product,
 - If the product has been exposed to rain or water,
 - If the product does not operate normally by following the operating instructions. Adjust only those controls that are covered by the operating instructions as an improper adjustment of other controls may result in damage and will often require extensive work by a qualified technician to restore the product to its normal operation.
 - If the product has been dropped or damaged in any way, and
 - If the product exhibits a distinct change in performance - this indicates a need for service.
- 21. Replacement Parts** - When replacement parts are required, be sure the service technician has used replacement parts specified by the manufacturer or have the same characteristics as the original part. Unauthorized substitutions may result in fire, electric shock, or other hazards.
- 22. Safety Check** - Upon completion of any service or repairs to this product, ask the service technician to perform safety checks to determine that the product is in proper operating condition.
- 23. Wall or Ceiling Mounting** - The product should be mounted to a wall or ceiling only as recommended by the manufacturer.
- 24. Heat** - The product should be situated away from heat sources such as radiators, heat registers, stoves, or other products (including amplifiers) that produce heat.



Introduction

READ THIS BEFORE OPERATING YOUR UNIT

	CAUTION RISK OF ELECTRIC SHOCK DO NOT OPEN	
CAUTION : TO REDUCE THE RISK OF ELECTRIC SHOCK, DO NOT REMOVE COVER (OR BACK). NO USER-SERVICEABLE PARTS INSIDE. REFER SERVICING TO QUALIFIED SERVICE PERSONNEL.		

	This symbol is intended to alert the user to the presence of uninsulated "dangerous voltage" within the product's enclosure that may be of sufficient magnitude to constitute a risk of electric shock to persons.
	This symbol is intended to alert the user to the presence of important operating and maintenance (servicing) instructions in the literature accompanying the appliance.

ENGLISH

WARNING : TO REDUCE THE RISK OF FIRE OR ELECTRIC SHOCK, DO NOT EXPOSE THIS APPLIANCE TO RAIN OR MOISTURE.

Caution regarding installation
 Note : For heat dispersal, do not install this unit in a confined space such as a bookcase or similar enclosure.

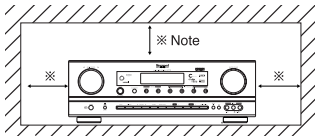

※ Note

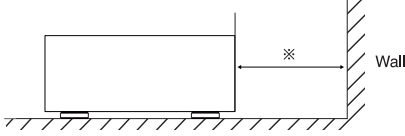

Wall

Do not block ventilation openings or stack other equipment on the top.

Note to CATV System Installer :
 This reminder is provided to call the CATV system installer's attention to Article 820-40 of the NEC that provides guidelines for proper grounding and, in particular, specifies that the cable ground shall be connected to the grounding system of the building, as close to the point of cable entry as practical.

FCC INFORMATION
 This equipment has been tested and found to comply with the limits for a Class B digital device, pursuant to Part 15 of the FCC Rules. These limits are designed to provide reasonable protection against harmful interference in a residential installation. This equipment generates, uses and can radiate radio frequency energy and, if not installed and used in accordance with the instructions, may cause harmful interference to radio communications. However, there is no guarantee that interference will not occur in a particular installation. If this equipment does cause harmful interference to radio or television reception, which can be determined by turning the equipment off and on, the user is encouraged to try to correct the interference by one or more of the following measures:

- Reorient or relocate the receiving antenna.
- Increase the separation between the equipment and receiver.
- Connect the equipment into an outlet on a circuit different from that to which the receiver is connected.
- Consult the dealer or an experienced radio/TV technician for help.

Caution : Any changes or modifications in construction of this device which are not expressly approved by the party responsible for compliance could void the user's authority to operate the equipment.

FOR YOUR SAFETY		
U.S.A CANADA	120 V	Units shipped to the U.S.A and CANADA are designed for operation on 120 V AC only. Safety precaution with use of a polarized AC plug. However, some products may be supplied with a nonpolarized plug. CAUTION : To prevent electric shock, match wide blade of plug to wide slot, fully insert. ATTENTION : Pour éviter chocs électriques, introduire la lame la plus large de la fiche dans la borne correspondante de la prise et pousser jusqu' au fond.

CAUTION

- Leave a space around the unit for sufficient ventilation.
- Avoid installation in extremely hot or cold locations, or in an area that is exposed to direct sunlight or heating equipment.
- Keep the unit free from moisture, water, and dust.
- Do not let foreign objects in the unit.
- The ventilation should not be impeded by covering the ventilation openings with items, such as newspapers, table-cloths, curtains, etc.
- No naked flame sources, such as lighted candles, should be placed on the unit.
- Please be care the environmental aspects of battery disposal.
- The unit shall not be exposed to dripping or splashing for use.
- No objects filled with liquids, such as vases, shall be placed on the unit.
- Do not let insecticides, benzene, and thinner come in contact with the set.
- Never disassemble or modify the unit in any way.
 - Notes on the AC power cord and the wall outlet.
- The unit is not disconnected from the AC power source(mains) as long as it is connected to the wall outlet, even if the unit has been turned off.
- When disconnecting the power cord from the wall outlet, always pull the plug, not the power cord.
- Disconnect the plug from the wall outlet when not using the unit for long periods of time.
- The wall outlet shall be installed near the unit and shall be easily accessible.

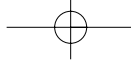

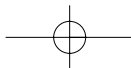

CONTENTS

ENGLISH

• SAFETY INSTRUCTIONS	2
• Introduction	
READ THIS BEFORE OPERATING YOUR UNIT	3
• System Connections	5
• Front Panel Controls	15
• Universal Remote Controls	17
OPERATING COMPONENTS WITH REMOTE CONTROL	19
REMOTE CONTROL OPERATION RANGE	19
LOADING BATTERIES	19
USING FUNCTIONS OF REMOTE CONTROL	20
• ROOM 2 Remote Controls	
REMOTE CONTROL OPERATION RANGE	29
LOADING BATTERY	29
• Operations	
LISTENING TO A PROGRAM SOURCE	30
SURROUND SOUND	32
ENJOYING SURROUND SOUND	34
LISTENING TO RADIO BROADCASTS	38
LISTENING TO XM SATELLITE RADIO	40
(XM Satellite Radio (only for North America))	
OTHER FUNCTIONS	43
ROOM 2 SOURCE PLAYBACK	44
RECORDING	45
DIGITAL AUDIO RECORDING WITH MD RECORDER	46
• OSD Menu Settings	47
SETTING THE SYSTEM SETUP	49
SETTING THE INPUT SETUP	53
SETTING THE SPEAKER / ROOM EQ SETUP	57
SETTING THE CH LEVEL SETUP	64
SETTING THE SOUND PARAMETER	66
SETTING THE MULTI ROOM SETUP	70
• Troubleshooting Guide	71
• Specifications	72
• Setup Code Table	73

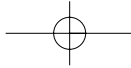

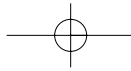

System Connections

- Please be certain that this unit is unplugged from the AC outlet before making any connections.
- Since different components often have different terminal names, carefully read the operating instructions of the component connected.
- Be sure to observe the color coding when connecting audio, video and speaker cords.
- Make connections firmly and correctly. If not, it can cause loss of sound, noise or damage to the receiver.

ENGLISH

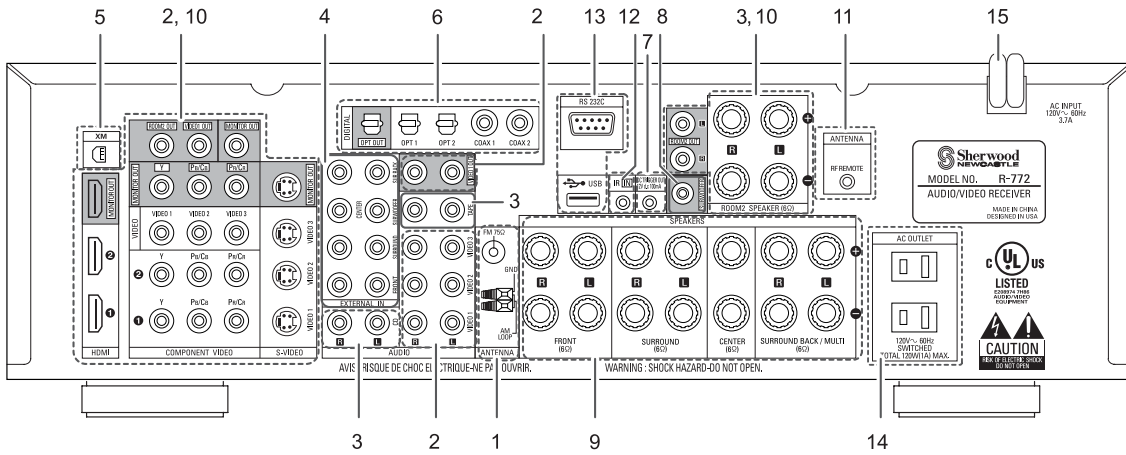

1. CONNECTING ANTENNAS

FM Indoor Antenna

FM Outdoor Antenna

- Change the position of the FM indoor antenna until you get the best reception of your favorite FM stations.
- A 75Ω outdoor FM antenna may be used to further improve the reception. Disconnect the indoor antenna before replacing it with the outdoor one.

AM Loop Antenna

AM Outdoor Antenna

- Place the AM loop antenna as far as possible from the receiver, TV set, speaker cords and the AC input cord and set it to a direction for the best reception.
- If the reception is poor with the AM loop antenna, an AM outdoor antenna can be used in place of the AM loop antenna.

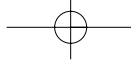

2. CONNECTING VIDEO COMPONENTS

- The jacks of VIDEO 1 may also be connected to a DVD recorder or other digital video recording component.
For details, refer to the operating instructions of the component to be connected.
- The jacks of VIDEO 2/VIDEO 3 can also be connected to an additional video component such as a cable TV tuner or satellite system.
- Connect the jacks of VIDEO 3 to the video component in the same way.

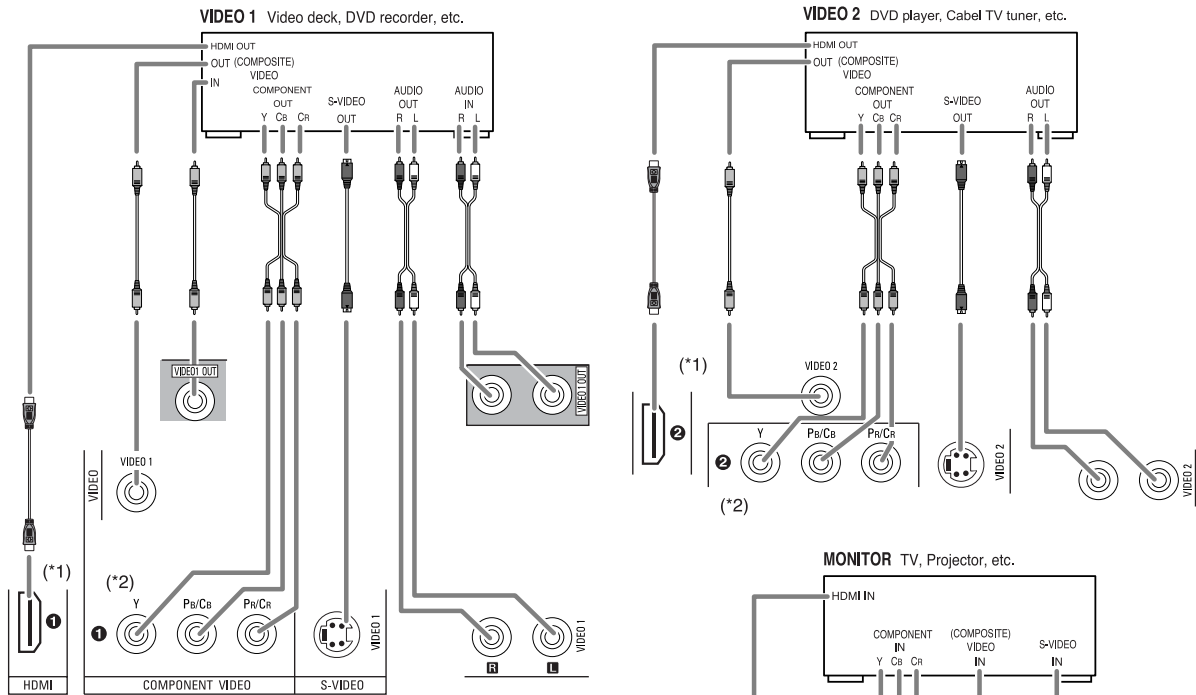

- There are three types of video jacks (COMPONENT, S-VIDEO, (composite) VIDEO) for analog video connections and the HDMI connectors for digital video and audio connections. Connect them to the corresponding video jacks according to their capability.
- For your reference, the excellence in picture quality is as follows : "HDMI" > "COMPONENT" > "S-VIDEO" > "(composite) VIDEO" .
- When making COMPONENT VIDEO connections, connect "Y" to "Y", "Pb/Cb" to "Cb"(or "B-Y", "PB") and "Pr/CR" to "Cr"(or "R-Y", "PR").
- When recording video program sources through VIDEO 1 OUT jacks or viewing ROOM 2 source through ROOM 2 OUT jacks, you must use the same type of video jacks that you did connect to video playback components such as DVD player, cable TV tuner, etc.
- This unit is equipped with a function that up-converts composite video or S-Video signals to component video signals or down-converts S-Video signals to composite video signals and outputs them from the MONITOR OUTs.
Because of this, you need not connect all the types of the MONITOR OUT jacks to the MONITOR TV.
- After connecting the video components, you should set the video mode correctly, referring to the following table on page 7. (For details, refer to "When selecting the VIDEO MODE" on page 54.)

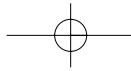

Continued

■ Relationship between the video input signal and the video output signal

Video input signals			Video Mode Setting	MONITOR OUTs		
COMPONENT	S-VIDEO	(COMPOSITE) VIDEO		COMPONENT	S-VIDEO	(COMPOSITE) VIDEO
○	○	○	Auto	Component	S-Video	Composite video*3
			Component*1	Component	×	×
			S-Video*2	S-Video	S-Video	S-Video
			Composite*2	Composite video	Composite video	Composite video
○	○	×	Auto	Component	S-Video	S-Video
○	×	○	Auto	Component	Composite video	Composite video
○	×	×	Auto	Component*4	×	×
×	○	○	Auto	S-Video	S-Video	Composite video*3
×	○	×	Auto	S-Video	S-Video	S-Video
×	×	○	Auto	Composite video	Composite video	Composite video

*1 : Component video signal can be output from the COMPONENT MONITOR OUT jacks only.

In his case, the OSD menu and the momentary OSD cannot be displayed.

*2 : The video signal set in the VIDEO MODE menu can be output from all the types of MONITOR OUT jacks.

*3 : The OSD menu and the momentary OSD cannot be displayed via (COMPOSITE) VIDEO MONITOR OUT jack.

*4 : If the OSD menu operation is performed, the picture is automatically turned off and only the OSD menu is displayed via COMPONENT MONITOR OUT jacks.

■ Note :

- When outputting the component video signal from the COMPONENT MONITOR OUT jacks as it was input, the momentary OSD cannot be displayed.

■ HDMI (High Definition Multimedia Interface) connection : (*1)

- You can connect the source component (DVD player, etc.) to the display component (TV, projector, etc.) through this receiver with using a commercially available HDMI cord.
- The HDMI connection can carry uncompressed digital video signals and digital audio signals.
- The HDMI video stream signals (video signals) are theoretically compatible with DVI-D. When connecting to a TV monitor, etc., equipped with DVI-D connector, it is possible to connect using a commercially available HDMI-DVI converter cord. Since the HDMI-to-DVI connection cannot carry any audio signals, you should make audio connections to play the audio signals on the component equipped with DVI-D connector. (For details, refer to the operating instructions of its.)
- If you connect the HDMI INs to your video components, it is easier to do so following the default settings.
- If your HDMI connection is different from the default setting, you should assign the HDMI INs you used with the "When selecting the HDMI ASSIGN" procedure on page 54.
- The default settings are as follows :
HDMI 1 : VIDEO 1, HDMI 2 : VIDEO 2

■ Copyright protection system

- This unit supports HDCP (High-bandwidth Digital Contents Protection), technology to protect copyright of digital video signals against illegal duplication. HDCP must also be supported on the components connected to this unit.
- This unit is HDMI Ver. 1.3 compatible.
- HDMI, the HDMI logo and High-Definition Multimedia Interface are trademarks or registered trademarks of HDMI licensing LLC.

■ Notes :

- For stable signal transfer, we recommend using HDMI cords that are a maximum of 5 meters in length.
- Among the components that support HDMI, some components can control other components via the HDMI connector. However, this unit cannot be controlled by another component via the HDMI connector.
- The audio signals from the HDMI connector (including the sampling frequency and bit length) may be limited by the component that is connected.
- The video signals will not be output properly if a component incompatible with HDCP is connected.
- If the resolutions of the video signals which are output from the HDMI MONITOR OUT and your monitor TV are not matched, the picture is not clear, natural or displayed. In this case, change the setting of the resolution on the source component (DVD player, etc.) to one which the monitor TV can handle. (For details, refer to the operating instructions of the source component.)
- When you want to enjoy only the picture on your TV, not the sound, you should set the HDMI AUDIO OUT to OFF not to output the digital audio signal from the HDMI MONITOR OUT of this receiver. (For details, refer to "When selecting the HDMI AUDIO OUT" on page 50.)

■ Component video input default settings: (*2)

- If you connect the COMPONENT VIDEO INs to your video components, it is easier to do so following the default settings.
- If your component video connections are different from the default setting, you should assign the COMPONENT VIDEO INs you used with the "When selecting the VIDEO ASSIGN" procedure on page 54.
- The default settings are as follows:
COMPONENT IN 1 : VIDEO 1, COMPONENT IN 2 : VIDEO 2.

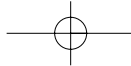

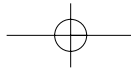

ENGLISH

3. CONNECTING AUDIO COMPONENTS

- For analog audio recording, the ROOM 2 OUT jacks can be connected to audio recording equipment such as a tape deck, an MD recorder, etc. as shown beside.

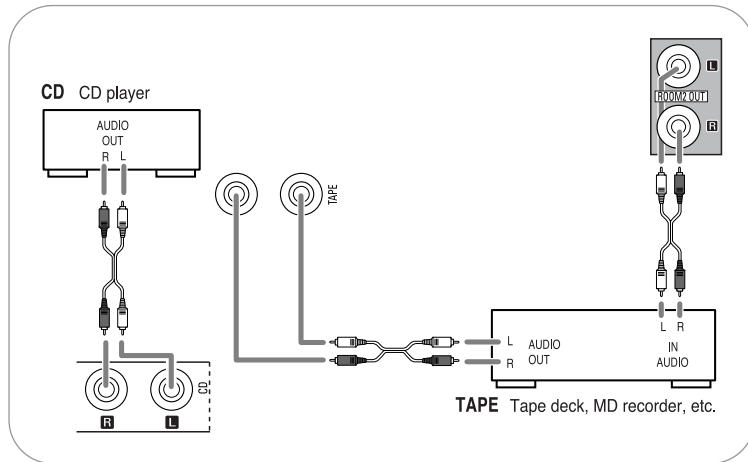

4. CONNECTING EXTERNAL INS

- Use these jacks to connect the corresponding outputs of a DVD player or external decoder, etc. that has 6, 7 or 8 channel analog audio outputs.
- In case of 6 or 7 channel outputs, do not connect both of the SURROUND BACK L and R inputs or the SURROUND BACK R input of this unit. (For details, refer to the operating instructions of the component to be connected.)

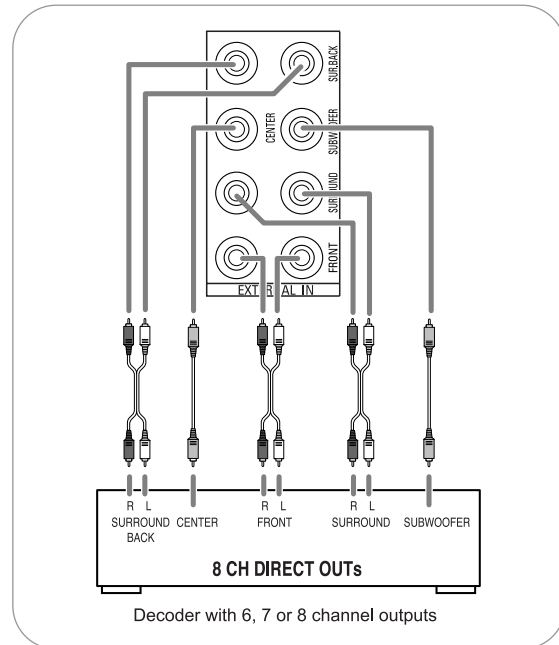

5. CONNECTING XM (only for North America)

- Connect the XM terminal to the XM Mini-Tuner system (sold separately).
- Position the XM Mini-Tuner system near a south-facing window to receive the best signal. When making connections, also refer to the operating instructions of the XM Mini-Tuner system.
- For the best reception, check the signal strength of the XM radio signal with using signal strength display mode, then adjust the position of the XM Mini-Tuner system until "GOOD" is displayed. (For details, refer to "Displaying XM information" on page 42.)
- To listen to XM Satellite Radio, refer to "XM Satellite Radio (only for North America)" on page 40.

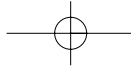
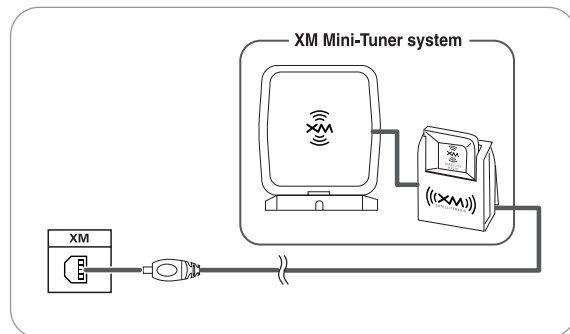

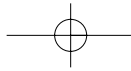

6. CONNECTING DIGITAL IN AND OUT

- The OPTICAL and the COAXIAL DIGITAL OUTs of the components that are connected to this unit can be connected to these DIGITAL INs.
- A digital input should be connected to the components such as a CD player, DVD player, etc. capable of outputting DTS Digital Surround, Dolby Digital or PCM format digital signals, etc.
- If the component with OPTICAL IN jack is connected to the OPTICAL OUT jack of this unit, you can record the high quality sound of CDs, etc. without degradation.
- For details, refer to the operating instructions of the component connected.
- When making the COAXIAL DIGITAL connection, be sure to use a 75 Ω COAXIAL cord, not a conventional AUDIO cord.
- All of the commercially available optical fiber cords cannot be used for the equipment. If there is an optical fiber cord which cannot be connected to your equipment, consult your dealer or nearest service organization.

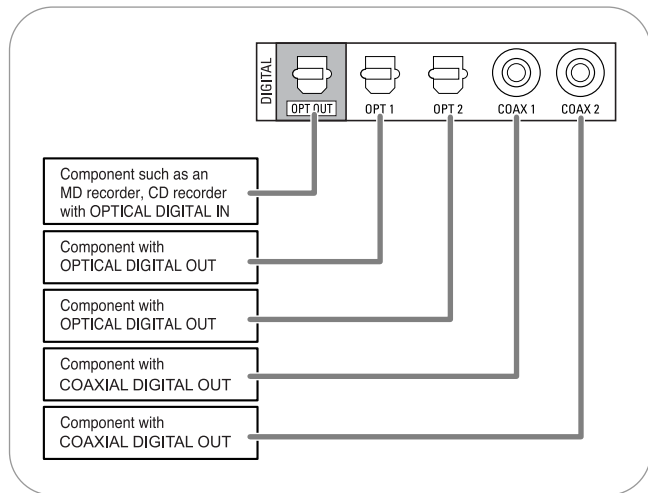

ENGLISH

■Notes:

- Be sure to make either a OPTICAL or a COAXIAL DIGITAL connection on each component. (You don't need to do both.)
- Depending on the digital audio signal format input into HDMI IN connector, some digital signals cannot be output from the OPTICAL OUT jack.

■Digital input default settings

- If you connect the DIGITAL INs to your components, it is easier to do so following the default settings.
- If your DIGITAL connections are different from default settings, you should assign the DIGITAL INs you used with the "When selecting the AUDIO ASSIGN" procedure on page 54.
- The default settings are as follows :
OPTICAL IN 1 : VIDEO 1, OPTICAL IN 2 : VIDEO 2, COAXIAL IN 1 : CD, COAXIAL IN 2 : AUX.

7. CONNECTING DC TRIGGER OUT

- Connect a component to DC TRIGGER OUT jack that allows DC 12V to turn on when a specific input source is selected.
- For details, refer to the operating instructions of the components to be connected.
- To link DC TRIGGER OUT with a specific input source, refer to "When selecting the DC TRIGGER" on page 55.

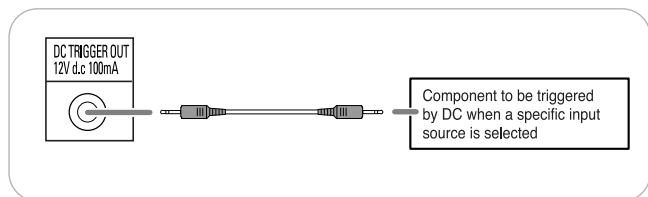

■Notes:

- This output voltage (12V d.c., 100mA) is for (status) control only, it is not sufficient for drive capability.
- When making DC TRIGGER connection, you should use the stereo mini cord, not a mono mini cord.

8. CONNECTING SUBWOOFER PREOUT

- To emphasize the deep bass sounds, connect a powered subwoofer.

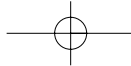
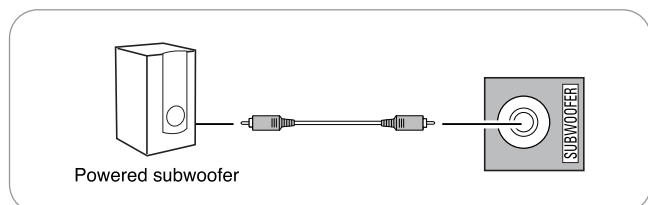

9. CONNECTING SPEAKERS

- Be sure to connect speakers firmly and correctly according to the channel(left and right) and the polarity (+ and -). If the connections are faulty, no sound will be heard from the speakers, and if the polarity of the speaker connection is incorrect, the sound will be unnatural and lack bass.
- For installing the speakers, refer to "Speaker placement" on page 11.
- After installing the speakers, first adjust the speaker settings according to your environment and speaker layout. (For details, refer to "SETTING THE SPEAKER/ROOM EQ SETUP" on page 57.)

■ Surround back speakers

- When using only one surround back speaker, you should connect it to SURROUND BACK/MULTI LEFT channel.
- Because this receiver cannot drive the surround back speakers and the ROOM 2 speakers simultaneously, you should assign their power amplifier correctly depending on how to use them.
(For details, refer to "CONNECTING ROOM 2 OUTS" on page 12 and "When selecting the AMP ASSIGN" on page 49.)

■ Front Bi-Amp Connections.

- Some speakers are equipped with two sets of input terminals, for bi-amplification.
- If no other surround back speakers are used, you can connect the FRONT and the SURROUND BACK/MULTI channels to the bi-amp-capable speakers. (For details, refer to the operating instructions of your bi-amp-capable speakers.)
- To drive the bi-amp-capable speakers, you should assign the power amplifier to "BI-AMP".

■ Note :

- Before making bi-amp connections, remove the short-circuiting bars from the terminals of your speakers.

Caution :

- Be sure to use the speakers with the impedance of 6 ohms or above.
- Do not let the bare speaker wires touch each other or any metal part of this unit. This could damage this unit and/or the speakers.

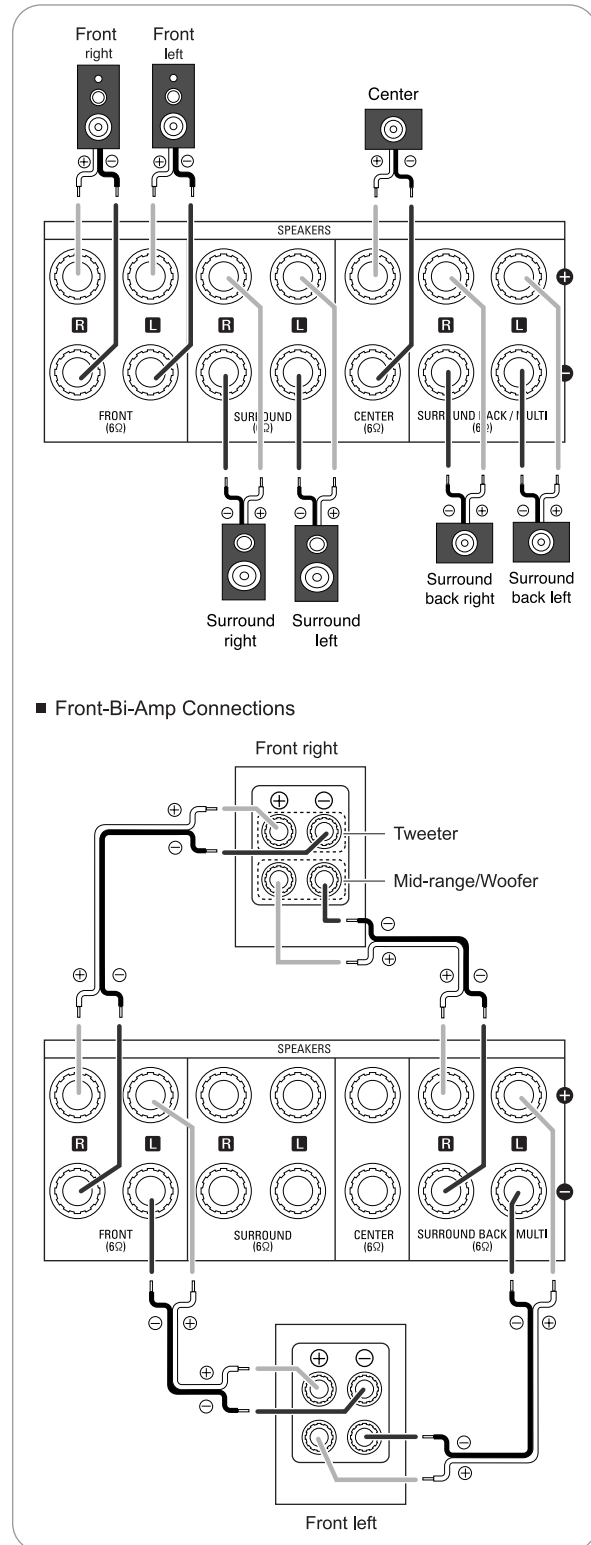

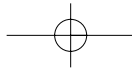

Speaker placement

Ideal speaker placement varies depending on the size of your room and the wall coverings, etc. The typical example of speaker placement and recommendations are as follows :

■ Front left and right speakers and center speaker

- Place the front speakers with their front surfaces as flush with TV or monitor screen as possible.
- Place the center speaker between the front left and right speakers and no further from the listening position than the front speakers.
- Place each speaker so that sound is aimed at the location of the listener's ears when at the main listening position.

■ Surround left and right speakers

- Place the surround speakers approximately 1 meter (40 inches) above the ear level of a seated listener on the direct left and right of them or slightly behind.

■ Surround back left and right speakers

- Place the surround back speakers at the back facing the front at a narrower distance than front speakers.
- When using a single surround back speaker, place it at the rear center facing the front at a slightly higher position (0 to 20 cm) than the surround speakers.
- We recommend installing the surround back speaker(s) at a slightly downward facing angle. This effectively prevents the surround back channel signals from reflecting off the TV or screen at the front center, resulting in interference and making the sense of movement from the front to the back less sharp.

■ Subwoofer

- The subwoofer reproduces powerful deep bass sounds.
Place a subwoofer anywhere in the front as desired.

■ Notes :

- When using a conventional TV, to avoid interference with the TV picture, use only magnetically shielded front left and right and center speakers.
- To obtain the best surround effects, the speakers except the subwoofer should be full range speakers.

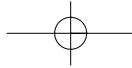
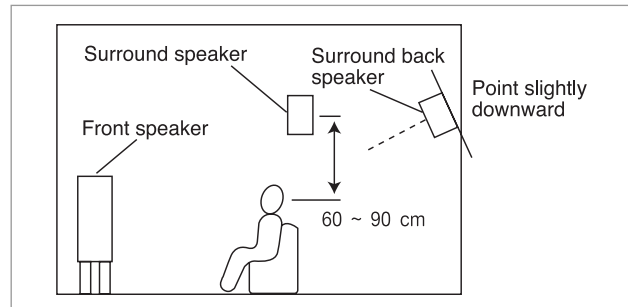
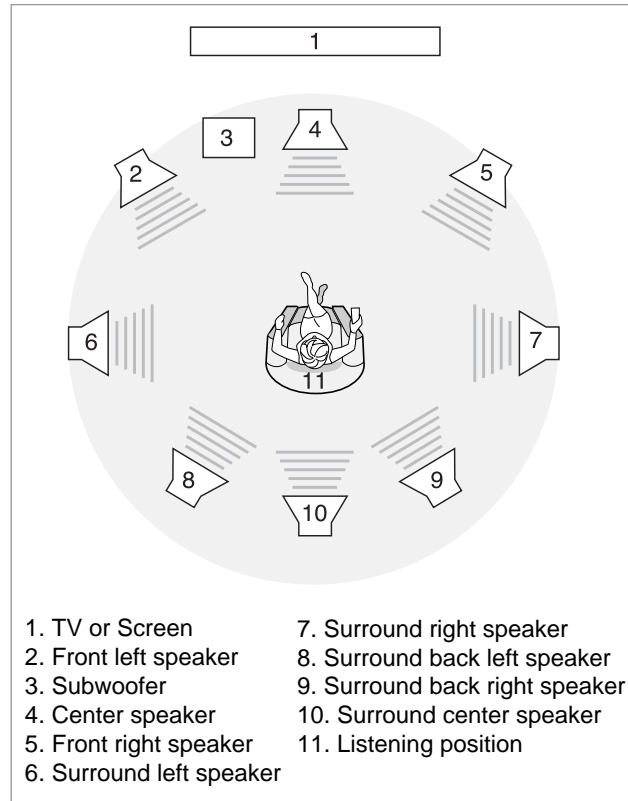

10. CONNECTING ROOM 2 OUTS

- ROOM 2 playback feature allows you to play a different program source in another room as well as one source in the main room at the same time.
- For ROOM 2 playback, connect the ROOM 2 OUT jacks to the amplifier, TV, etc. installed in another room, or connect the ROOM 2 speaker terminals to the speakers.
- Because this receiver cannot drive the surround back speakers and the ROOM 2 speakers simultaneously, you should assign their power amplifier correctly depending on how to use them. (For details, refer to "When selecting the AMP ASSIGN" on page 49.)
- When the ROOM 2 (AUDIO) OUT jacks are not connected to the ROOM 2 amplifier, you can connect these jacks to audio recording equipment such as a tape deck, an MD recorder, etc. for analog audio recording. (For details, refer to "CONNECTING AUDIO COMPONENTS" on page 8.)

■ Notes :

- To minimize hum or noise, use high quality connection cords.
- You cannot use the digital audio signal for ROOM 2 playback.

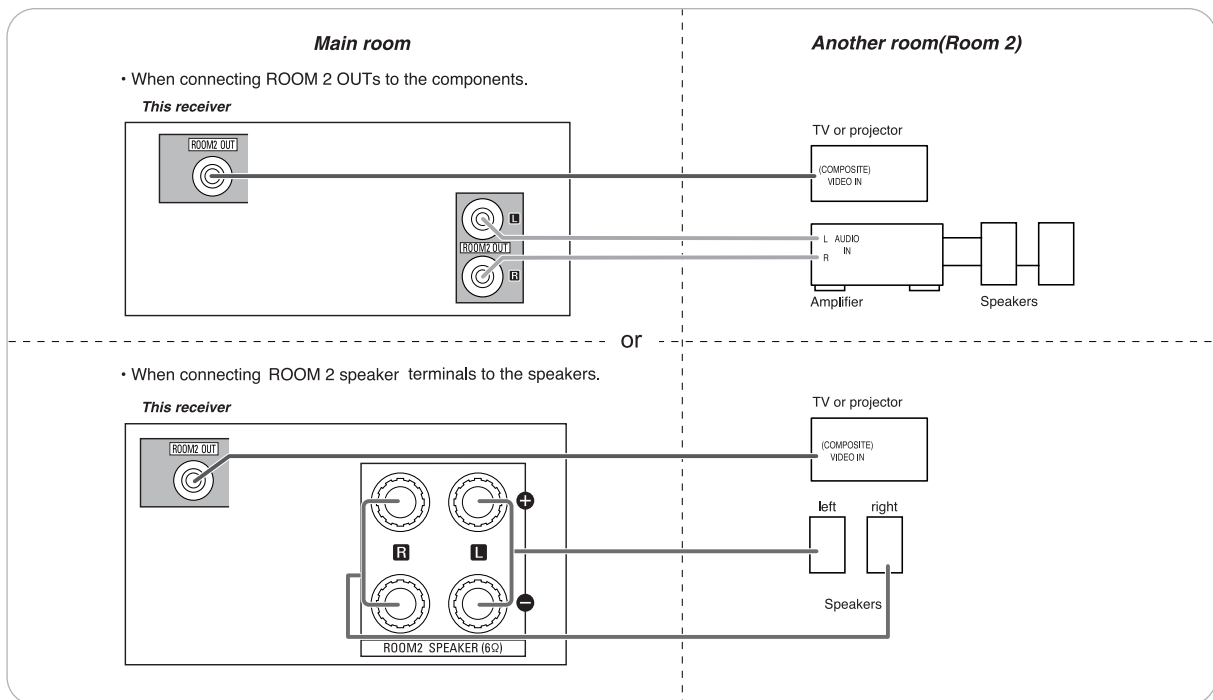

11. CONNECTING RF REMOTE ANTENNA

- Connect the supplied antenna to receive the RF (Radio Frequency) beams from the universal remote control.
- If the antenna is connected to this receiver, even though there are obstacles such as walls, furniture, etc. in the way, you can control this receiver with the universal remote control. Therefore, you can control this receiver from another room with the universal remote control without connecting the multi-room system kit. (For details, refer to "CONNECTING MULTI-ROOM SYSTEM KIT" on page 13.)

■ Note:

- If the walls are too thick or the distance exceeds the operation range, you cannot control this receiver with the universal remote control. In such a case, connect the multi-room system kit to this receiver and set the transmission signal mode to "IR"(Infrared). (For details, refer to "Changing the transmission signal" on page 28.)

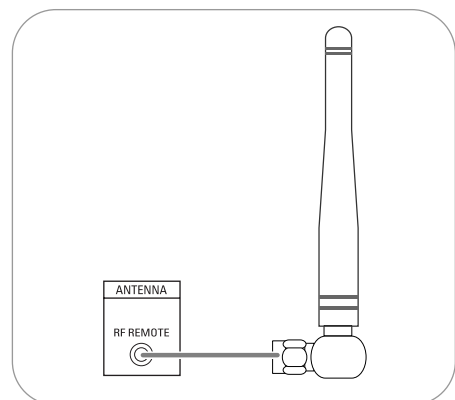

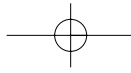

12. CONNECTING MULTI-ROOM SYSTEM KIT

- The multi-room system kit(sold separately) is essential for operation from a remote location . For information on the multi-room system kit, contact the Xantech corporation at 1-800-843-5465 or www.xantech.com.
- IR IN jack allows you to control this receiver from another room with the remote control unit.
- To control this receiver from another room with the remote control unit, connect the IR IN jack to the output of the connecting block.
- If this receiver is located inside a cabinet or other enclosure where the signals from the remote control unit cannot enter, then operation with the remote control unit will not be possible. In such a case, connect the IR IN jack to the output of the connecting block.

■ Notes:

- Remote operation may become unreliable if the IR receiver is exposed to strong light such as direct sunlight or inverted fluorescent.
- When the transmission signal mode is set to "RF", the IR receiver cannot accept the RF beams from the universal remote control and remote operation will become unreliable.

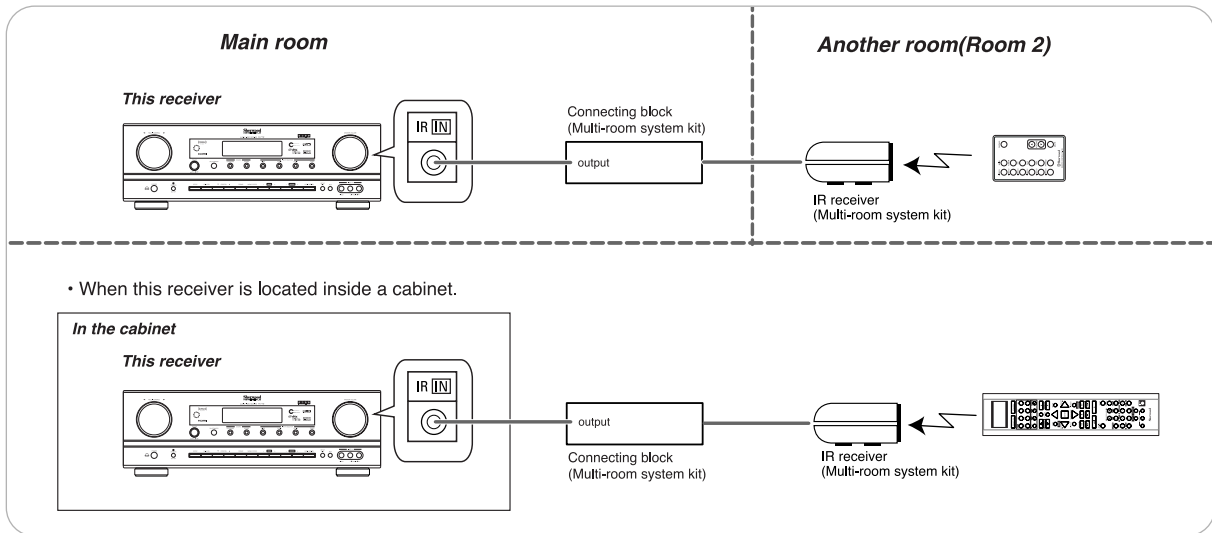

13. CONNECTING PC FOR UPGRADES

- This receiver incorporates USB as well as RS-232C terminal that may be used in the future to update the operating software so that it will be able to support new digital audio formats, external control by using an external device and the like.
- Connect either USB or RS-232C terminal to your PC (you don't need to do both).

■ Notes:

- Programming for upgrades and external control requires specialized programming knowledge and for that reason we recommend that it only be done by qualified installers. For more information on future upgrades and external control, visit the Sherwood web site at www.sherwoodamerica.com or contact your dealer.
- Do not disconnect the connection cable while updating the operating software, etc. Should this happen, it may be result in malfunction or cause damage to the unit.

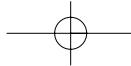
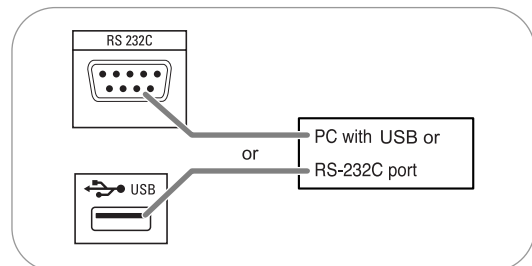

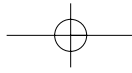

14. SWITCHED AC OUTLETS

- These outlets are switched on (power-on mode) and off (standby mode) according to power control as follows (Maximum total capacity is 120 W (1A)).

- Standby mode - Switched AC outlet off
- Power - on mode - Switched AC outlet on

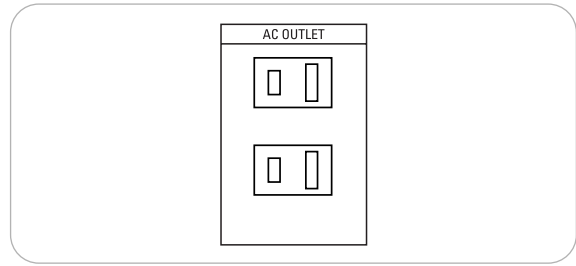

15. AC INPUT CORD

- Plug this cord into a wall AC outlet.

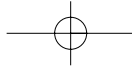

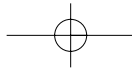

Front Panel Controls

The diagram shows the front panel of the Sherwood Newcastle R-772 receiver. It features a central fluorescent display, a multi-control knob on the left, and a master volume knob on the right. Various buttons for power, surround mode, stereo, and tuning are arranged across the top. The bottom section contains a row of buttons for setup, channel levels, room settings, and memory/enter functions, along with several jacks for headphones, speaker, and video.

- POWER switch
- POWER ON/STANDBY button/indicator
- VIDEO INPUT SELECTOR button
- AUDIO INPUT SELECTOR button
- EXTERNAL IN button
- TUNER button
- MASTER VOLUME CONTROL knob
- HEADPHONE jack
- SPEAKER button/indicator
- SURROUND MODE button
- STEREO button
- SETUP button
- CHANNEL LEVEL button
- CONTROL UP/DOWN (▲/▼) buttons
- ROOM 2 button
- MEMORY/ENTER button
- TUNING UP/DOWN(+/-) buttons
- PRESET UP/DOWN(+/-) buttons
- AUDIO ASSIGN button
- EXTERNAL IN button
- SETUP MIC jack
- AUX IN jack
- VIDEO 4 IN jacks

ENGLISH

FLUORESCENT DISPLAY

The diagram shows the fluorescent display with various indicators and callout numbers. The display shows 'ST TUNED R2', 'PRESET MEM', 'dB kHz MHz', and 'DTS ES 96/24 NEO:6 D EX D PLI x DSP AUTO DIGITAL DIRECT'. Callouts 1 through 12 point to specific indicators on the display.

- Input, frequency, volume level, operating information, etc.
- Surround mode indicators
- AUTO indicator
- DIGITAL INPUT indicator
- DIRECT indicator
- Preset number, sleep time display
- MEMORY indicator
- PRESET indicator
- SLEEP indicator
- ROOM 2 indicator
- TUNED indicator
- STEREO indicator

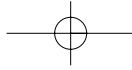

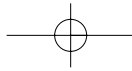

ENGLISH

■ SETUP MIC JACK

- To use Auto Setup function, connect the supplied microphone to the SETUP MIC jack. (For details, refer to "When selecting the AUTO SETUP" on page 57.)

■ Notes:

- Because the microphone for Auto Setup is designed for use with this receiver, do not use a microphone other than the one supplied with this receiver.
- After you have completed the auto setup procedure, disconnect the microphone.

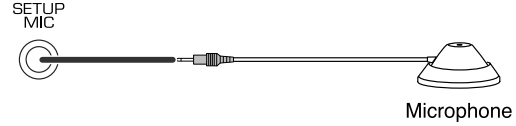

■ AUX IN JACK

- The AUX IN jack can be connected to an additional audio component such as an MP3 player, etc.

■ Note :

- When connecting this jack to an MP3 player, etc., you should use the stereo mini cord, not a mono mini cord.

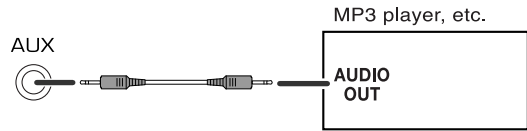

■ VIDEO 4 IN JACKS

- The VIDEO 4 IN jacks may be also connected to an additional video component such as a camcorder, a video game player, etc.

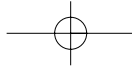
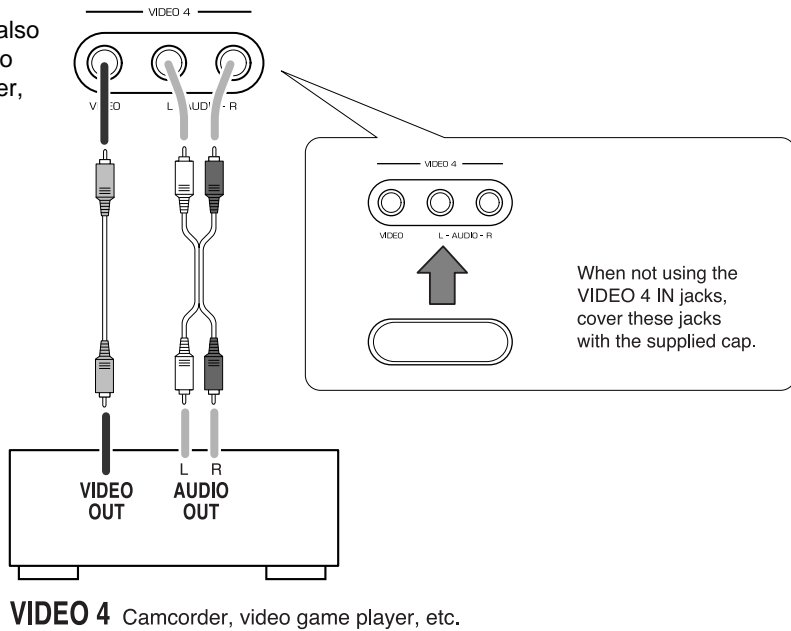

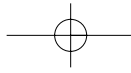

Universal Remote Controls

This universal remote control can operate not only this receiver but also most popular brands of audio and video components such as CD players, tape decks, TVs, cable boxes, VCRs, DVD players, satellite receivers, etc.

- To operate 7 components other than this receiver, you should enter the setup code for each component. (For details, refer to "USING FUNCTIONS OF REMOTE CONTROL" on page 20.)
- The numbered buttons on the remote control have different functions in different device modes. For details, refer to "FUNCTION TABLE of the NUMBERED BUTTONS" on the next page.

■ About the transmission signal

This remote control can emit not only the infrared beams which the conventional remote control(including the ROOM 2 remote control) uses but also the RF(Radio Frequency) beams which are stronger than those.

To operate this receiver and other components, this remote control should emit the infrared beams.

To operate this receiver only from longer distance even if there are obstacles such as walls, furniture, etc. in the way, this remote control should emit the RF beams.

Therefore, depending on how to use this remote control, you should set the transmission signal mode to "IR"(default value) or "RF". (For details, refer to "Changing the transmission signal" on page 28.)

■ Notes :

- To receive the RF beams, you should connect the RF remote antenna to this receiver. (For details, refer to "CONNECTING RF REMOTE ANTENNA" on page 12.)
- If the transmission signal mode is set to "RF", this remote control cannot control other audio and video components.

ENGLISH

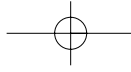
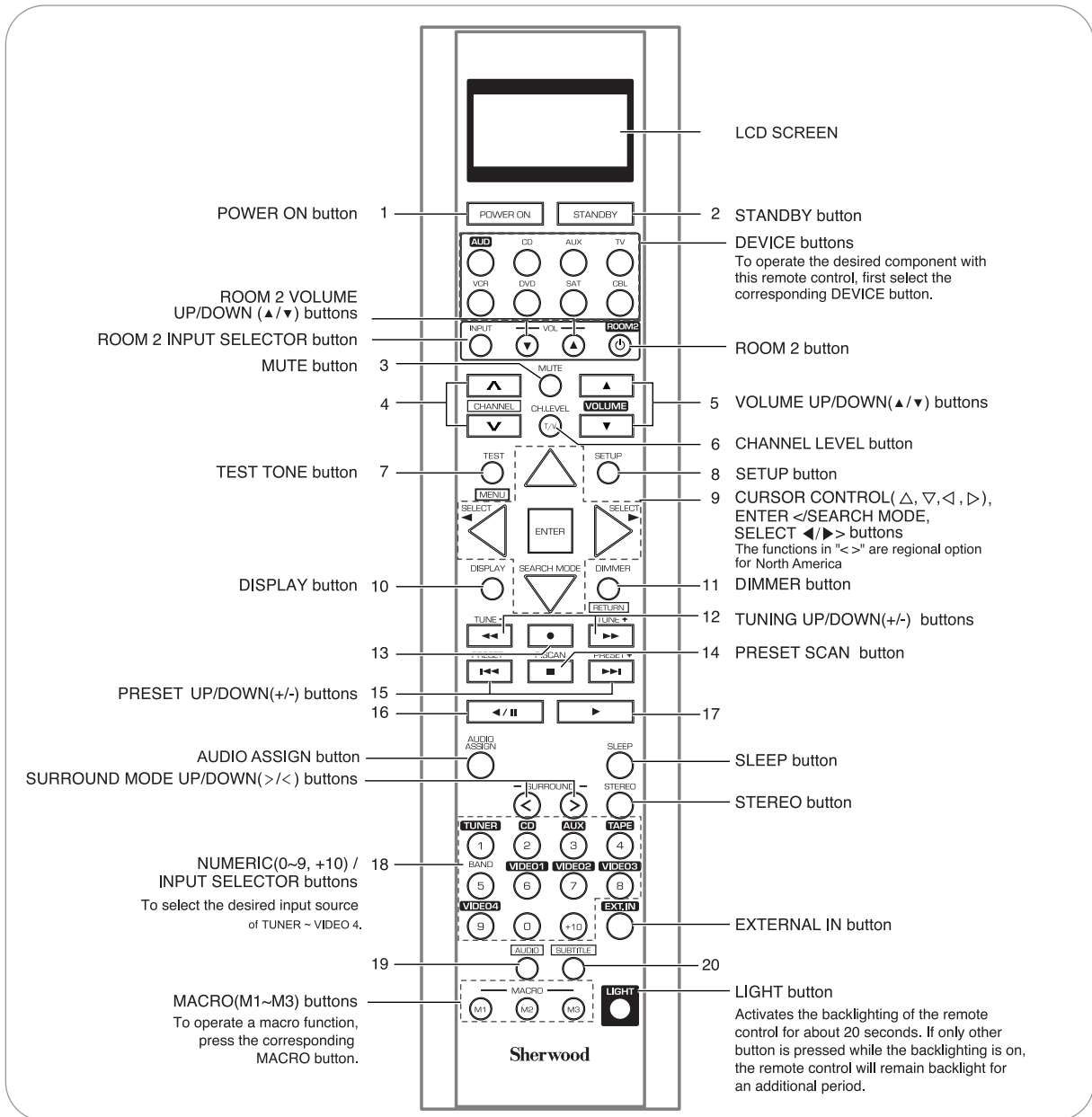

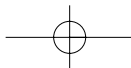

ENGLISH

■FUNCTION TABLE of the NUMBERED BUTTONS.

Device to be controlled	CD (for CD player)	AUX (for tape deck)	TV (for TV)	VCR (for VCR)	DVD (for DVD player)	SAT (for satellite receiver)	CBL (for cable box)
1	POWER ON	POWER ON	POWER ON	POWER ON	POWER ON	POWER ON	POWER ON
2	STANDBY (POWER OFF)	STANDBY (POWER OFF)	STANDBY (POWER OFF)	STANDBY (POWER OFF)	STANDBY (POWER OFF)	STANDBY (POWER OFF)	STANDBY (POWER OFF)
3	—	—	MUTE	MUTE	—	MUTE	MUTE
4	—	—	CHANNEL UP/DOWN(▲/▼)	CHANNEL UP/DOWN(▲/▼)	—	CHANNEL UP/DOWN(▲/▼)	CHANNEL UP/DOWN(▲/▼)
5	—	—	VOLUME UP/DOWN(▲/▼)	VOLUME UP/DOWN(▲/▼)	—	VOLUME UP/DOWN(▲/▼)	VOLUME UP/DOWN(▲/▼)
6	—	—	INPUT SELECTOR	INPUT SELECTOR	—	INPUT SELECTOR	INPUT SELECTOR
7	—	—	—	—	MENU	—	—
8	—	—	—	—	SETUP	—	—
9	—	—	—	—	CURSOR CONTROL	—	—
					ENTER		
10	—	—	—	—	DISPLAY	—	—
11	—	—	—	—	RETURN	—	—
12	REVERSE SEARCH(◀◀) / FORWARD SEARCH(▶▶)	REWIND(◀◀) / FAST FORWARD(▶▶)	—	REWIND(◀◀) / FAST FORWARD(▶▶)	REVERSE SEARCH(◀◀) / FORWARD SEARCH(▶▶)	—	—
13	—	RECORD	—	RECORD	—	—	—
14	STOP	STOP	—	STOP	STOP	—	—
15	REVERSE SKIP(◀◀) / FORWARD SKIP(▶▶)	—	—	—	REVERSE SKIP(◀◀) / FORWARD SKIP(▶▶)	—	—
16	PAUSE	REVERSE PLAY	—	PAUSE	PAUSE	—	—
17	PLAY	FORWARD PLAY	—	PLAY	PLAY	—	—
18	NUMERIC	—	NUMERIC	NUMERIC	NUMERIC	NUMERIC	NUMERIC
19	—	—	—	—	AUDIO	—	—
20	—	—	—	—	SUBTITLE	—	—

■Notes :

- Some functions for each component may not be available or may work differently.
- Depending on other kinds of components that are available for each DEVICE button, some functions may not be available or may work differently, too.
- For details about functions, refer to the operating instructions of each component.

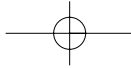

OPERATING COMPONENTS WITH REMOTE CONTROL

1. Enter the setup code for each component other than this receiver. For details, refer to "Entering a setup code" on page 20.
2. Turn on the component you want to operate.
3. Press the DEVICE button on the remote control corresponding to the component you wish to operate.
4. Aim the remote control at the REMOTE SENSOR of the component you wish to control and press the button corresponding to the operation you want.

■ Note :

- When you cannot operate any component, check if the transmission signal mode is set to "RF". (For details, refer to "Changing the transmission signal" on page 28.)

LOADING BATTERIES

- When the remote control does not operate, the old batteries should be replaced. In this case, load new batteries within several minutes after removing old batteries.
- If the batteries are removed or have been exhausted for a longer period of time, memorized contents will be cleared. Should this happen, you should memorize them again.

1. Remove the cover.

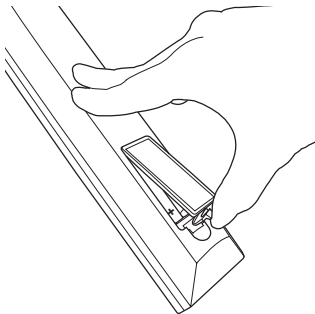

REMOTE CONTROL OPERATION RANGE

- In case that this remote control emits the infrared beams
- Use the remote control within a range of about 7 meters (23 feet) and angles of up to 30 degrees aiming at the remote sensor.

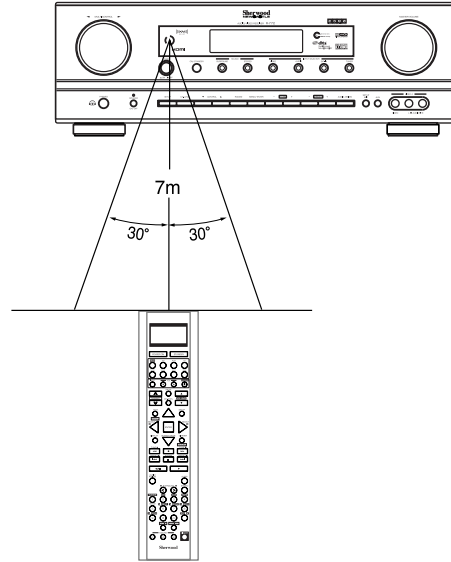

- In case that this remote control emits the RF beams
- Use the remote control within a distance of about 10 meters (33 feet) toward this receiver.

2. Load four alkaline batteries ("AAA" size, 1.5V) matching the polarity.

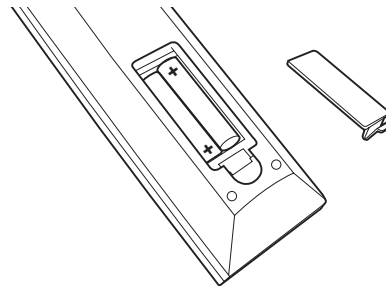

- Remove the batteries when they are not used for a long time.
- Do not use the rechargeable batteries (Ni-Cd type).
- Be sure to use alkaline batteries.

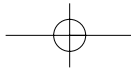

USING FUNCTIONS OF REMOTE CONTROL

- This remote control can control up to 8 different components.
- Before operating audio and video components other than this receiver with using this remote control, the setup code for each component should be entered.
- For system remote control operation, "000" was stored previously in the memory of the device button "CD" for Sherwood CD player, "DVD" for Sherwood DVD player, "AUX" for Sherwood tape deck and "TV" for Sherwood TV respectively as its factory setup code. So, you don't need to enter its code for each Sherwood component except in such a case that its code does not work.
- Note :
 - If the transmission signal which this remote control emits is changed into "RF"(Radio Frequency), this remote control cannot control other audio and video components. (For details, refer to "Changing the transmission signal" on page 28.)

Entering a setup code

- Setup code entry is the easiest way to program this remote control for operating audio and video components.

1. Turn on the component you want to operate.

2. Find the setup codes according to the type and the brand name of your component, referring to "Setup Code Table" on page 73.

3. Press and hold down both the ENTER button and the desired one of the DEVICE buttons for more than 2 seconds.

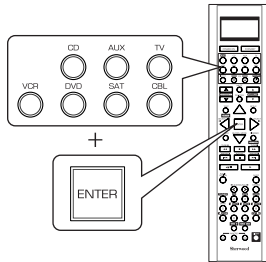

- Then "LEARN" is displayed on the LCD screen for several seconds.

■ Notes :

- The AUDIO button is unavailable for the audio components other than this receiver.
- During setting operation, to exit from the setting mode, press any of the DEVICE buttons.

4. While "LEARN" is displayed, press the CURSOR UP(▲)/DOWN(▼) buttons to select the setup code mode ("CODE"), then press the ENTER button.

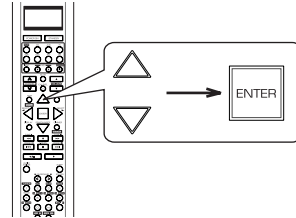

- Each time the CURSOR UP(▲)/DOWN(▼) buttons are pressed, the mode changes as follows :
 - ↳ LEARN ↔ RF-IR ↔ DELETE ↔ MACRO
 - ↳ CODE ↔ PUNCH

- Then "PRESET" and 3 digit number are displayed.
- If "PRESET", etc. go off, start again from the above step 3.

5. While "PRESET", etc. are displayed, enter a 3 digit code and press the ENTER button, aiming the remote sensor on the component.

Example: When entering "001".

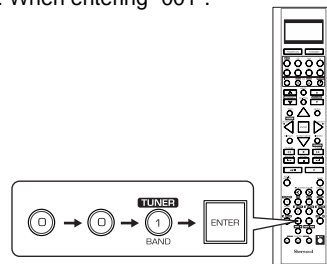

- Then "OK" is displayed on the LCD screen.
- To be sure that the setup code is correct, press the POWER ON (or STANDBY) button.
- If the setup code is correct, your component will be turned off.
- When your component is not turned off, repeat the above steps 2 to 5, trying entering each code for your component until you find one that works.
- If "NG" is displayed, retry entering the correct setup code while "PRESET" and 3 digit number are displayed.

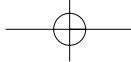

6. Operate the component using the corresponding function buttons.

- If any of buttons fails to operate as they should, start from the step 1 again to enter the correct setup code.

■ **Note :**

- Manufacturers may use different setup codes for the same product category. For that reason, it is important that you check to see if the code you have entered operates as many controls as possible. If only a few functions operate, check to see if another code will work with more buttons.

7. Repeat the above steps 1 to 6 for each of your other components.

Searching a setup code

- In addition to enter a setup code using "Setup Code Table" on page 73, it is also possible to search through all the codes that are stored in the library of this remote control.

1. Turn on the component you want to operate.

2. Perform the steps 3 and 4 in "Entering a setup code" procedure on page 20 to select the setup code mode ("CODE").

3. While "PRESET" is displayed, search a setup code, aiming the remote control at the remote sensor on the component.

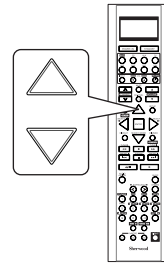

- Each time the CURSOR UP(▲)/DOWN(▼) buttons are pressed, the setup code is selected one by one.
- If the selected code is correct, your component will be turned off.
- When your component is not turned off, repeat this step until you find one that works.

4. While "PRESET" is displayed, press the ENTER button to store the setup code.

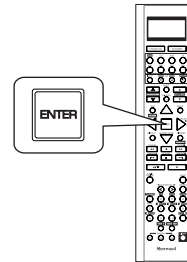

- Then "OK" is displayed on the LCD screen.

5. Operate the component using the corresponding function buttons.

- If any of buttons fails to operate as they should, start from the step 1 again to find the correct setup code.

6. Repeat the above steps 1 to 5 for each of your other components.

Programing the commands from other remote controls (LEARNING mode)

- If the setup codes are not available for your component or you want to program a missing or special function into one button of a device, the learning function enables this remote control to learn the commands from other remote controls.

1. Place this remote control and other remote control facing each other at a distance of 5 to 15 cm (2 to 6 inches) apart.

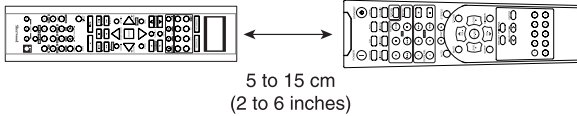

2. Press and hold down the ENTER button and the desired one of the DEVICE buttons for more than 2 seconds.

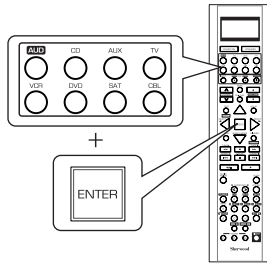

- Then "LEARN" is displayed on the LCD screen for several seconds
- Note :
- During setting operation, to exit from the setting mode, press any of the DIVICE buttons.

3. While "LEARN" is displayed, press the ENTER button.

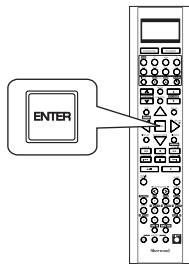

- Then "SEL" is flickering.
- If "SEL" goes off, start again from the above step 2.

4. While "SEL" is flickering, on this remote control, press the button corresponding to the function to be learned.

Example: If the function to be learned is playback, press the PLAY(▶) button.

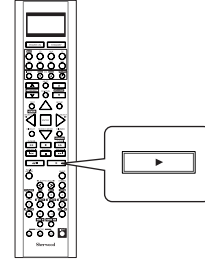

- Then "READY" is displayed.
- Note:
- You cannot program a function into some buttons such as DEVICE, MACRO and LIGHT buttons.

5. While "READY" is displayed, on the other remote control, press the button of the function to be learned.

- If the command has been learned successfully, "OK" is displayed and then "SEL" is flickering.
- If "ERROR" is displayed and then "SEL" is flickering, it means that for some reason the command was not learned. In this case, repeat the above steps 4 and 5.

■ Notes :

- If an incorrect signal has been sent or, in some cases, the command from other remote control simply cannot be learned.
- In some "ERROR" cases, the remote controls just need to be moved closer together or farther apart.

6. While "SEL" is flickering, repeat the above steps 4 and 5 to program all the commands you want to the buttons on this remote control under the same device mode.

- To exit from the setting mode, press any of the DEVICE buttons.

7. Repeat the above steps 1 to 6 to program the commands from a different remote control.

8. Operate the newly programmed buttons to make sure the learning function was performed properly.

Erasing the programmed command from one button

1. Perform the steps 3 and 4 in "Entering a setup code" procedure on page 20 to select the deleting mode ("DELETE").
 - Then "BTTN" is displayed on the LCD screen for several seconds.
2. While "BTTN" is displayed, press the CURSOR UP(▲)/DOWN(▼) buttons to select the one command deleting mode (BTTN), then press the ENTER button.

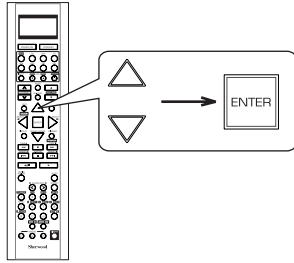

- Each time the CURSOR UP(▲)/DOWN(▼) buttons are pressed, "BTTN" or "LEARN"(all command deleting mode) is selected.
 - Then "SEL" is flickering.
 - If "SEL" goes off, start again from the above step 1.
3. While "SEL" is flickering, press the button for the command you want to erase.

Example: When the button for the command to be erased is PLAY button.

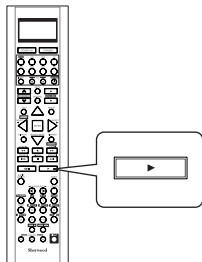

- "OK" is displayed and then "SEL" is flickering.
4. While "SEL" is flickering, repeat the above step 3 to erase other commands.

Erasing all the commands programmed under a device mode

1. Perform the steps 3 and 4 in "Entering a setup code" procedure on page 20 to select the deleting mode ("DELETE").
 - Then "BTTN" is displayed on the LCD screen for several seconds.
2. While "BTTN" is displayed, press the CURSOR UP(▲)/DOWN(▼) buttons to select the all command deleting mode ("LEARN"), then press the ENTER button.

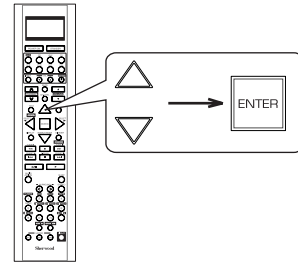

- Then "SURE?" is displayed .
 - If "SURE?" goes off, start again from the above step 1
3. While "SURE?" is displayed, press the ENTER button.

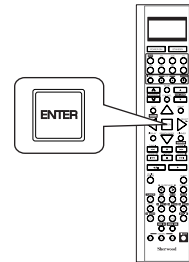

- Then all the commands programmed are erased.
4. To erase all the commands programmed under other device mode, repeat the above steps 1 to 3.

Programming a macro function

- The macro function enables you to program a series of button operations (up to 15) on this remote control into a single button.
- You can store up to three separate macro command sequences into "M1", "M2" and "M3" buttons.

1. Perform the steps 3 and 4 in "Entering a setup code" procedure on page 20 to select the macro mode ("MACRO").

- Then "M1" is displayed on the LCD screen for several seconds.
- During macro setting operation, pressing any of the DEVICE buttons cannot exit from the macro mode.

2. While "M1" is displayed, press the CURSOR UP(▲)/DOWN(▼) buttons to select the MACRO button to be programmed into, then press the ENTER button.

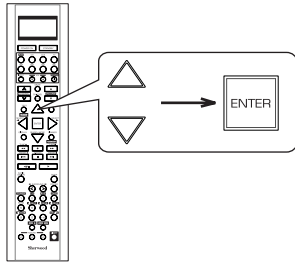

- Each time the CURSOR UP(▲)/DOWN(▼) buttons are pressed, "M1", "M2" or "M3" is selected.
- Then "SEL" is flickering.
- If "SEL" goes off, start again from the above step 1.

3. While "SEL" is flickering, press the operation buttons you want to program in order.

Example: When playing a DVD on the DVD player connected to VIDEO 2 jacks of this receiver.

- ①. Press "AUDIO" button to control this receiver.
- ②. Press "POWER ON" button to turn this receiver on.
- ③. Press "VIDEO 2(7)" button to select the desired input source.
- ④. Press "DVD" button to control the DVD player.
- ⑤. Press "POWER ON" button to turn the DVD player on.
- ⑥. Press "PLAY (▶)" button to start playback.



- Each time the operation buttons are pressed, the programmed order is displayed.

4. Press any of the MACRO buttons (M1~M3) to complete the programming.

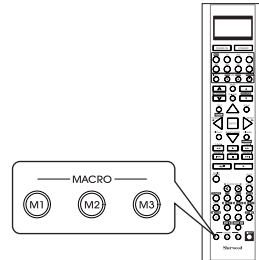

- Then "OK" is displayed.

■ To erase a macro program

- When erasing a macro program, perform the above steps 1, 2 and 4, but ignore the step 3.

■ To change a macro program

- When a new macro program is stored into a MACRO button with performing the above steps 1 to 4, the previous macro program is erased from the memory of the MACRO button.

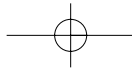

Operating a macro function

- Aim the remote control at the REMOTE SENSORS of the components to be controlled and press the MACRO button you want.
Example : When pressing "M1" button.

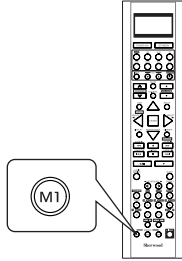

■ Notes:

- The codes programmed into a MACRO button will be transmitted at an interval of 0.5 seconds. However, some components may not be able to complete one operation in 0.5 seconds and may miss the next code. In this case, the macro function cannot control the corresponding components correctly.
- Be sure to use the remote control within the remote control operation range of the components.
- Depending on the operation status of the components, etc., the macro function cannot control the corresponding components correctly.

Programing a punch-through function

- The punch-through function allows the volume controls, channel controls or transport controls to link to a different device while a device is controlled with this remote control as a master device.
- For example, since this receiver will likely be used as the sound system while watching TV, you may want to use volume controls to operate this receiver although this remote control is set to control the TV.

1. Perform the steps 3 and 4 in "Entering a setup code" procedure on page 20 to select a master device and the punch-through mode ("PUNCH").

- Then "VOL" is displayed on the LCD screen for several seconds.

2. While "VOL" is displayed, press the CURSOR UP(▲)/DOWN(▼) buttons to select the desired punch-through mode, then press the ENTER button.

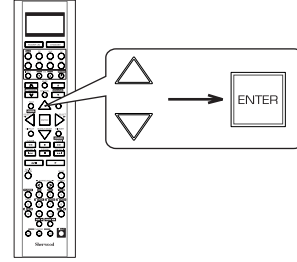

- Each time the CURSOR UP(▲)/DOWN(▼) buttons are pressed, the mode changes as follows:
 - VOL : The volume punch-through mode allows the "VOLUME ▲/▼" and "MUTE" buttons to operate a different device.
 - ↕
 - DELETE : All punch-through deleting mode.
 - ↕
 - PLAY : The transport punch-through mode allows the "◀◀", "●", "▶▶", "I◀◀", "■", "▶▶", "◀/||" and "▶" buttons to operate a different device.
 - ↕
 - CH : The channel punch-through mode allows the "CHANNEL ▲/▼" and "CH. LEVEL" buttons to operate a different device.
- Then the device to which you can link the selected punch-through mode is displayed.

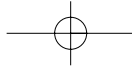

Continued

- 3.** While the device is displayed, press the CURSOR UP(▲)/DOWN(▼) buttons to select the desired punch-through device, then press the ENTER button.

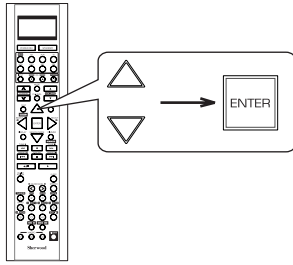

- Each time the CURSOR UP(▲)/DOWN(▼) buttons are pressed, depending on the selected punch-through mode, punch-through devices and the one punch-through deleting mode ("DELETE") are selected as follows :

- In case of the volume punch-through,
→ AUDIO ↔ DELETE ↔ TV ←
- In case of the transport punch-through,
→ CD ↔ DELETE ↔ DVD ↔ VCR ↔ AUX ←
- In case of the channel punch-through,
→ TV ↔ DELETE ↔ SAT ↔ CABLE ↔ VCR ←
- Then "OK" is displayed and the current punch-through mode is displayed.

- 4.** While the punch-through mode is displayed, repeat the above steps 2 and 3 to program other punch-through function under the same master device mode.

- 5.** To program punch-through functions under other master device mode, repeat the above steps 1 to 4.

Operating a punch-through function

- While this remote control is set to control a master device, aim the remote control at the REMOTE SENSOR of the punch-through device and press the desired button of the programmed punch-through controls.
Example: When pressing "PLAY (▶)" button.

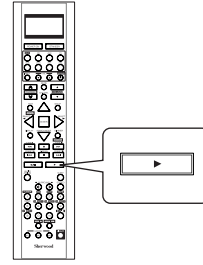

- Then the punch-through device is displayed on the LCD screen.

Erasing the programmed punch-through function

- 1.** Perform the steps 3 and 4 in "Entering a setup code" procedure on page 20 to select a master device and the punch-through mode ("PUNCH").

- Then "VOL" is displayed on the LCD screen for several seconds.

- 2.** While "VOL" is displayed, press the CURSOR UP(▲)/DOWN(▼) buttons to select the punch-through mode to be erased, then press the ENTER button.

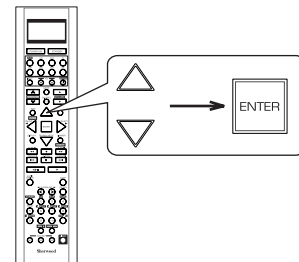

- Each time the CURSOR UP(▲)/DOWN(▼) buttons are pressed, the mode changes as follows:

→ VOL ↔ DELETE ↔ PLAY ↔ CH ←

- Then the device is displayed .

Continued

3. While the device is displayed, press the CURSOR UP(▲)/DOWN(▼) buttons to select the one punch-through deleting mode ("DELETE"), then press the ENTER button.

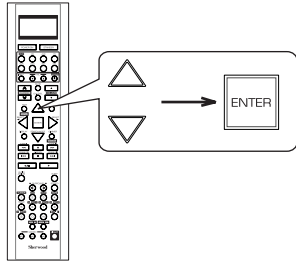

- Each time the CURSOR UP(▲)/DOWN(▼) buttons are pressed, depending on the selected punch-through mode, the punch-through devices and the deleting mode ("DELETE") are selected.
- Then "OK" is displayed and the current punch-through mode is displayed .

4. While the punch-through mode is displayed, repeat the above steps 2 and 3 to erase other punch-through function under the same master device mode.

5. To erase punch-through functions under other master device mode, repeat the above steps 1 to 4.

Erasing all the punch-through functions programmed under a master device mode

1. Perform the steps 3 and 4 in "Entering a setup code" procedure on page 20 to select a master device and the punch-through mode ("PUNCH").

- Then "VOL" is displayed on the LCD screen for several seconds.

2. While "VOL" is displayed, press the CURSOR UP(▲)/DOWN(▼) buttons to select the all punch-through deleting mode ("DELETE").

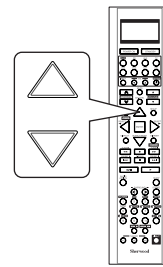

- Each time the CURSOR UP(▲)/DOWN(▼) buttons are pressed, the mode changes as follows:

→ VOL ↔ DELETE ↔ PLAY ↔ CH ←

- Then "DELETE" is displayed .

3. While "DELETE" is displayed, to erase all the punch-through functions programmed under the master device mode, press ENTER button.

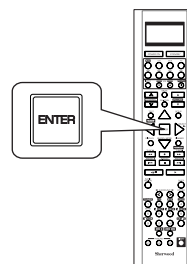

- Then "OK" is displayed and "DELETE" is displayed.
- To exit from the deleting mode, press any of the DEVICE buttons.

4. To erase all the punch-through functions programmed under other master device mode, repeat the above steps 1 to 3.

Changing the transmission signal

- This remote control can emit not only the infrared beams which the conventional remote control uses but also the RF(Radio Frequency) beams which are stronger than those.
- When you want to control this receiver from longer distance even if there are obstacles such as walls, furniture, etc. in the way, change the transmission signal into "RF"(Radio Frequency).

■ Notes:

- When the RF remote antenna is not connected, remote operation will become unreliable. (For details, refer to "CONNECTING RF REMOTE ANTENNA" on page 12.)
- If the transmission signal mode is set to "RF" (Radio Frequency), this remote control cannot control other audio and video components.

1. Press and hold down the ENTER button and any of the DEVICE buttons for more than 2 seconds.

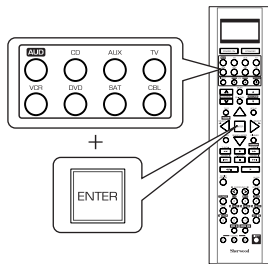

- Then "LEARN" is displayed on the LCD screen for several seconds.

■ Note:

- During setting operation, to exit from the setting mode, press any of the DEVICE buttons.

2. While "LEARN" is displayed, press the CURSOR UP(▲)/DOWN(▼) buttons to select the transmission signal mode("RF-IR"), then press the ENTER button.

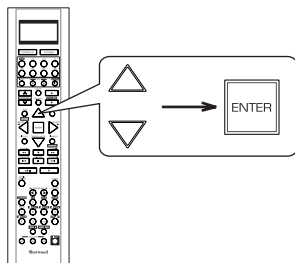

- Then "RF" (or "IR") is displayed.
- If "RF" (or "IR") goes off, start again from the above step 1.

3. While "RF" (or "IR") is displayed, press the CURSOR UP(▲)/DOWN(▼) buttons to select the desired transmission signal, then press the ENTER button.

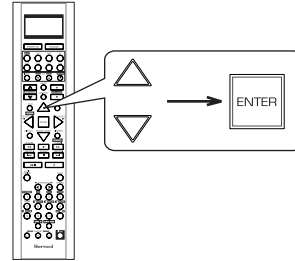

- Each time the CURSOR UP(▲)/DOWN(▼) buttons are pressed, the mode changes as follows :
 "RF" : This remote control emits the RF(Radio Frequency) beams which stronger than the infrared beams.
 ↑
 "IR" : This remote control emits the infrared beams which the conventional remote control uses.
 ↓
 • Then "OK" is displayed.

■ When "RF" is set to.

4. To pair up this remote control and the receiver, press the CONTROL DOWN(▼) button and the MEMORY/ENTER button simultaneously on the receiver.

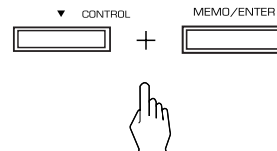

- "RF REMOCON PAIRING MODE" is displayed for several seconds on the display of the receiver.
- If "RF REMOCON PAIRING MODE" goes off, press these buttons again.

5. While "RF REMOCON PAIRING MODE" is displayed, press the ENTER button, aiming at the receiver.

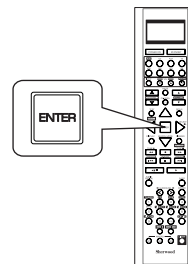

- Then "PAIRING SUCCESS" is displayed.

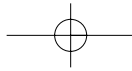

ROOM 2 Remote Controls

This remote control unit is an additional remote control unit for the ROOM 2 source playback only.

- You can use the ROOM 2 functions with this remote control unit more conveniently in another room than with the universal remote control unit.
- For details on ROOM 2 operation, refer to "ROOM 2 SOURCE PLAYBACK" on page 44.

REMOTE CONTROL OPERATION RANGE

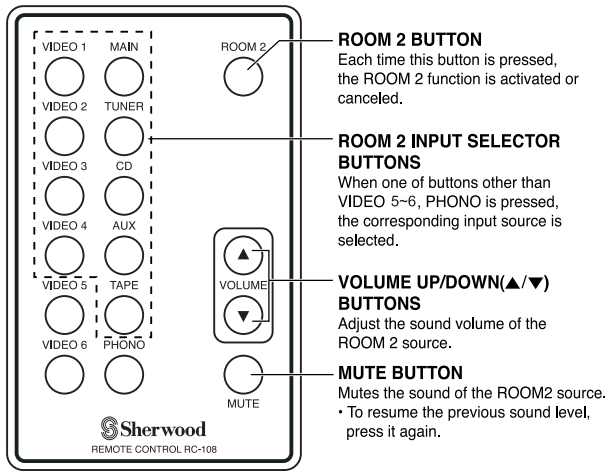

- Aim the ROOM 2 remote control at the IR receiver installed in another room. (For details, refer to "CONNECTING MULTI-ROOM SYSTEM KIT" on page 13.)

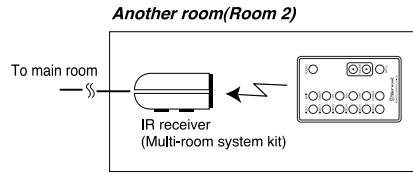

- When you operate the ROOM 2 function in the main room, aim the ROOM 2 remote control at the remote sensor of this receiver.

LOADING BATTERY

1. Remove the cover.

2. Load the battery (CR2025) matching the polarity.

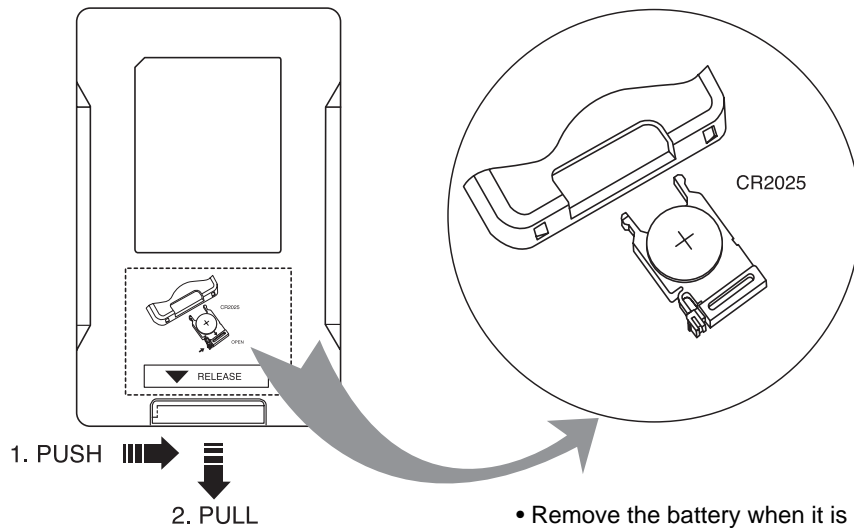

- Remove the battery when it is not used for a long time.

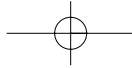

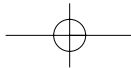

Operations

■Notes:

- Before operating this receiver with the supplied remote control, refer to "Universal Remote Controls" on page 17 for details about operation.
- Before operating this receiver, first set this unit as desired for optimum performance, doing the OSD menu setting procedures. (For details, refer to "OSD Menu Settings" on page 47.)

LISTENING TO A PROGRAM SOURCE

Before operation

- Enter the standby mode.
- The POWER ON/STANDBY button lights up amber. This means that the receiver is not disconnected from the AC mains and a small amount of current is retained to support the operation readiness.
- To switch the power off, push the POWER switch again. Then the power is cut off and the POWER ON/STANDBY button goes off.



1. In the standby mode, turn the power on.

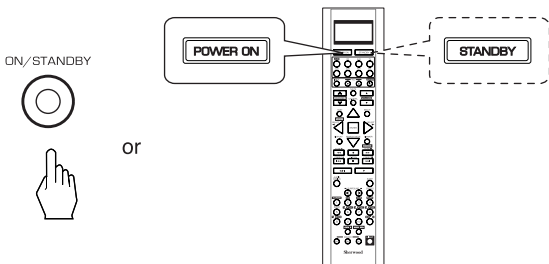

- Each time the POWER ON/STANDBY button on the front panel is pressed, the receiver is turned on to enter the operating mode (the POWER ON/STANDBY button lights up blue) or off to enter the standby mode (the POWER ON/STANDBY button lights up amber).
- On the remote control, press the POWER ON button to enter the operating mode or press the STANDBY button to enter the standby mode.
- In the standby mode, if the INPUT SELECTOR button is pressed, the receiver is turned on automatically and the desired input is selected.

2. Switch the speakers on.

- Then the SPEAKER indicator lights up and the sound can be heard from the speakers connected to the speaker terminals.
- When using the headphones for private listening, press the SPEAKER button again to switch the speakers off.



3. Select the desired input source.

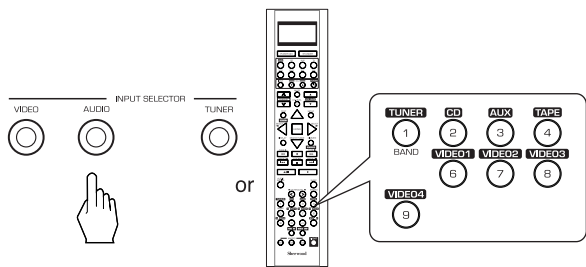

- Each time the "AUDIO" button on the front panel is pressed, the input source changes as follows:
→ CD → AUX → TAPE
- Each time the "VIDEO" button on the front panel is pressed, the input source changes as follows:
→ VIDEO 1 → VIDEO 2 → VIDEO 3 → VIDEO 4
- Each time the "TUNER" button is pressed, the band changes as follows:
→ FM STereo → FM MONO → AM → XM

■ When selecting the EXTERNAL IN as desired,

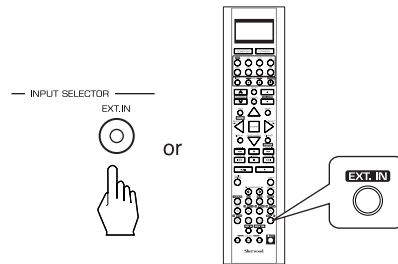

- Depending on the power amplifier setting for the surround back channels and the surround back speaker setting, "EXT. IN" is displayed and 8/(7/6) separate analog signals from the component connected to this input pass through the tone and volume circuits only and can be heard from your speakers.
- Select the desired input source to cancel the external in function.
- These analog signals can be heard only, not recorded.

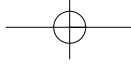

When CD, AUX, VIDEO 1~ 4 is selected as an input source

- If the AUDIO MODE is set to the mode other than "DIGITAL" for the corresponding input source on the INPUT SETUP menu, you cannot hear the sound from the selected digital input. (For details, refer to "SETTING THE INPUT SETUP" on page 53.)

4. Press the AUDIO ASSIGN button.

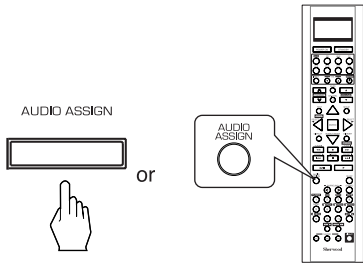

- "AUD ~ " is displayed for several seconds.
- "AUD ~ " disappears, press the AUDIO ASSIGN button again.

5. Select the desired of the digital inputs connected while displaying "AUD ~ ".

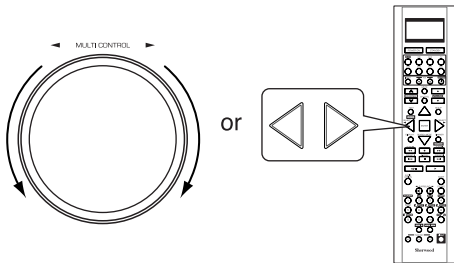

- Each time the MULTI CONTROL knob is rotated or the CURSOR LEFT (◀)/RIGHT (▶) buttons are pressed, the corresponding input is selected as follows :

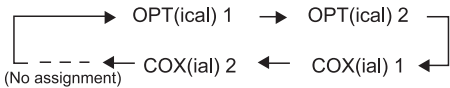

Notes:

- When the selected digital input is not connected or assigned, "o1", "c1", etc (, meaning no digital signal input from it) or "d" (, meaning no audio assignment) flickers and no sound will be heard.
- The selected digital input is automatically assigned to the corresponding input source on the INPUT SETUP menu. (For details, refer to "SETTING THE INPUT SETUP" on page 53.)
- The sound from the component connected to the selected digital input can be heard regardless of the selected input source.

6. Operate the selected component for playback.

- When playing back the program sources with surround sound, refer to "ENJOYING SURROUND SOUND" on page 34.

7. Adjust the (overall) volume.

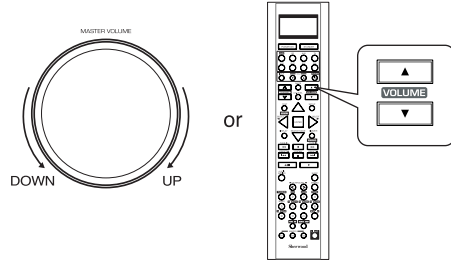

Muting the sound

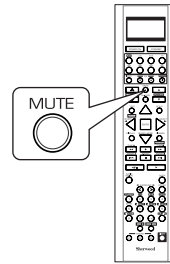

- "MUTE" flickers.
- To resume the previous sound level, press it again.

Listening with headphones

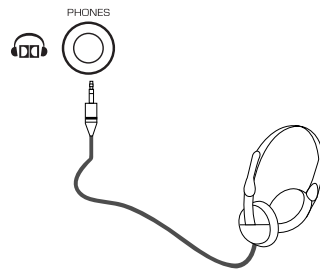

- Ensure that the SPEAKER button is set to off.
- Depending on the signal format which is being input, you can listen in Dolby Headphone mode, stereo mode, etc. (For details, refer to "Listening in Dolby Headphone mode" on page 35).
- When the EXTERNAL IN is selected as an input source, only front left and front right channel signals can be reproduced through the headphones.

Note:

- Be careful not to set the volume too high when using headphones.

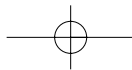

SURROUND SOUND

- This receiver incorporates a sophisticated Digital Signal Processor that allows you to create optimum sound quality and sound atmosphere in your personal Home Theater.

Surround modes

■ DTS Digital Surround

DTS Digital Surround(also called simply DTS) is a multi-channel digital signal format which can handle higher data rates. Discs bearing the "DTS" include the recording of up to



5.1 channels of digital signals, which can be generally thought to provide better sound quality due to the lower audio compression required.

It also provides wide dynamic range and separation, resulting in magnificent sound.

■ DTS - ES Extended Surround™ ()

This is a new multi channel digital signal format which greatly improves the 360- degree surround impression and space expression thanks to further expanded surround signals, offering high compatibility with the conventional DTS format. In addition to the 5.1 channels, DTS-ES Extended Surround also offers the surround back (sometimes also referred to as "surround center") channel for surround playback with a total of 6.1 channels. DTS-ES Extended Surround includes two signal formats with different surround signal recording methods as follows:

• DTS-ES™ Discrete 6.1

Because the signals for 6.1 channels (including the surround back channel) are fully independent, it is possible to achieve a sense that the acoustic image are moving about freely among the background sounds surrounding the listener from 360 degrees. Though maximum performance is achieved when sound tracks recorded with this system are played using a DTS -ES decoder, when played with a conventional DTS decoder, the surround back channel signals are automatically downmixed to the surround left and surround right channels so that none of the signal components are lost.

• DTS - ES™ Matrix 6.1

With this format, the additional surround back channel signals undergo matrix encoding and are input to the surround left and surround right channels beforehand. During playback, they are decoded to the surround left, surround right and surround back channels.

Because the bit stream format is 100% compatible with conventional DTS signals, the effect of the DTS-ES Matrix 6.1 format can be achieved even with DTS 5.1- channel signal sources. Of course, it is possible to play DTS-ES Matrix 6.1 - channel signal sources with a DTS 5.1 - channel decoder. When DTS-ES Discrete 6.1 or Matrix 6.1 sources are decoded with a DTS - ES decoder, the format is automatically detected upon decoding and the optimum surround mode is selected. However, some DTS - ES Matrix 6.1 sources may be detected as DTS sources. In this case, the DTS - ES Matrix mode should be selected manually to play these sources.

■ DTS Neo : 6™ surround

This mode applies conventional 2-channel signals such as digital PCM or analog stereo signals to the high precision digital matrix decoder used for DTS-ES Matrix 6.1 to achieve 6.1-channel surround playback. DTS Neo : 6 surround includes two modes for selecting the optimum decoding for the signal source.

• DTS Neo : 6 Cinema

This mode is optimum for playing movies. Decoding is performed with emphasis on separation performance to achieve the same atmosphere with 2-channel sources as with 6.1-channel sources.

• DTS Neo : 6 Music

This mode is suited mainly for playing music. The front left and front right signals bypass the decoder and are played directly so there is no loss of sound quality, and the effect of the surround signals from the center, surround left, surround right and surround back channels adds a natural sense of expansion to the sound field.

■ DTS 96/24

Conventional surround formats used sampling frequencies of 48 or 44.1 kHz, so 20 kHz was about the maximum playback signal frequency. With DTS 96/24, the sampling frequency is increased to 96 or 88.2 kHz to achieve a wide frequency range of over 40 kHz. In addition, this format has a resolution of 24 bits, resulting in the same frequency band and dynamic range as 96kHz / 24 bit PCM signals.

As with conventional DTS surround, DTS 96/24 is compatible with a maximum of 5.1 channels. DTS 96/24 is fully compatible with the conventional DTS surround format, so DTS 96/24 sources can be played using a conventional DTS 5.1 channel decoder.

"DTS" and "DTS-ES | Neo:6" are registered trademarks of DTS, Inc. "96/24" is a trademarks of DTS, Inc.

■ Dolby Digital

Dolby Digital is the multi- channel digital signal format developed by Dolby Laboratories. Discs bearing the "  " includes the recording of up to 5.1 channels of digital signals, which can reproduce much better sound quality, spatial expansion and dynamic range characteristics than the previous Do by Surround effect.

■ Dolby Digital EX

This mode creates the back (sometimes also referred to as "surround center") signals from the surround left and right signals in Do by Digital 5.1 channel source using a matrix decoder and provides 6.1 channel surround playback. For the best results, this mode should be selected during playback of sources(bearing the "  ") recorded in Do by Digital

EX. With this additional channel, you can experience more dynamic and realistic moving sound especially. When Dolby Digital EX sources are decoded with a Dolby Digital EX decoder, the format is automatically detected upon decoding and the Do by Digital EX mode is selected. However, some Dolby Digital EX sources may be detected as Dolby Digital sources. In this case, the Dolby Digital EX mode should be selected manually to play these sources.

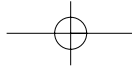

■ **Dolby Pro Logic IIx surround**

Dolby Pro Logic IIx decodes all stereo (2 channel) and 5.1 channel sources and extends to 7.1channel surround playback. It delivers the most natural, full range and immersing 7.1 channel listening experience. Dolby Pro Logic IIx surround includes three modes as follows :

• **Dolby Pro Logic IIx Movie**

When enjoying movies, this mode allows you to further enhance the cinematic quality by adding processing that emphasizes the sounds of the action special effects.

• **Dolby Pro Logic IIx Music**

When listening to music, this mode allows you to further enhance the sound quality by adding processing that emphasizes the musical effects.

• **Dolby Pro Logic IIx Game**

When playing games, this mode allows you to further enhance the dynamic surround effects by adding processing that emphasizes the surrounded and exciting sound.

■ **Dolby Pro Logic II surround**

This mode applies conventional 2-channel signals such as digital PCM or analog stereo signals as well as Dolby Surround signals, etc. to surround processing to offer improvements over conventional Do by Pro Logic circuits. Dolby Pro Logic II surround includes Dolby Pro Logic II Movie, Dolby Pro Logic II Music and Dolby Pro Logic II Game like Do by Pro Logic IIx surround.

■ **Dolby Virtual Speaker**

This mode creates a virtual surround sound field using as few as two front speakers, allowing you to experience listening from 5.1 channel speakers.

This mode is effective not only for 5.1 channel sources but also for stereo(2 channel) sources. Dolby Vlrutal Speaker includes two listening mode as follows:

• **Dolby Virtual Speaker Reference**

The width of the front sound image is defined by the actual distance between front speakers.

• **Dolby Virtual Speaker Wide**

The width of the front sound image seems to extend beyond the front speakers.

- When using the EXTERNAL INs to play back the sound from the additional multi-channel decoder for surround sound, you can enjoy the corresponding surround sound, too.(For details, refer to the operating instructions of the component to be connected.)

For your reference, the sound from each channel can be reproduced according to the surround modes as follows:

Modes	Channels	FRONT L/R	CENTER	SURROUND L/R	SURROUND BACK L/R	SUBWOOFER
DTS, DTS 96/24		○	○	○		○
DTS ES DISCRETE/MATRIX		○	○	○	○	○
DTS NEO: 6 C NEMA/MUSIC		○	○	○	○	(*)
DOLBY DIGITAL		○	○	○		○
DOLBY DIGITAL EX		○	○	○	○	○
DOLBY PRO LOGIC IIx MOVIE/MUSIC/GAME		○	○	○	○	○
DOLBY PRO LOGIC II MOVIE/MUSIC/GAME		○	○	○		○
DOLBY VIRTUAL SPEAKER		○	○	○		(*)
MULTI PCM		○	○	○	○/	○
Other Surrounds		○	○	○	○	(*)
STEREO		○				(*)
EXTERNAL IN		○	○	○	○	○

(*): Depending on the subwoofer setting, the sound from the subwoofer channel may be reproduced.

- Depending on the speaker settings and the number of the encoded channels, etc., the sound from the corresponding channels cannot be reproduced.(For details, refer to "SETTING THE SPEAKER / ROOM EQ SETUP" on page 57.)

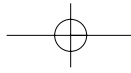

ENJOYING SURROUND SOUND

Notes:

- Before surround playback, first perform the speaker setup procedure, etc. on the OSD menu for optimum performance. (For details, refer to "SETTING THE SPEAKER/ROOM EQ SETUP" on page 57.)
- When playing digital signals from the Dolby Digital program source or selecting the surround mode such as Dolby Pro Logic II /Dolby Pro Logic IIx Music, Dolby Headphone, Do by Virtual Speaker modes, you can adjust their parameters for optimum surround effect. (For details, refer to "SETTING THE SOUND PARAMETER" on page 66.)
- When the EXTERNAL IN is selected as an input source, the surround modes cannot be selected.

Depending on how to select a surround mode, select the auto surround mode or the manual surround mode.



- Each time this button is pressed, the mode changes as follows :

Auto surround mode : The optimum surround mode will be ("AUTO" lights up.) automatically selected depending on the signal format being input.

Manual surround mode : You can select the desired of different surround modes selectable for the signal being input with using the MULTI CONTROL knob or the SURROUND MODE UP/DOWN (> / <) buttons.

Notes :

- Even when the auto surround mode is selected and the same type of digital signal format is being input, the optimum surround mode may vary depending on whether the speaker type is set to "NO" or not.
- When the auto surround mode is selected, the surround modes other than the optimum surround mode cannot be selected.

- When selecting the manual surround mode with pressing the SURROUND MODE button on the front panel. Select the desired surround mode.

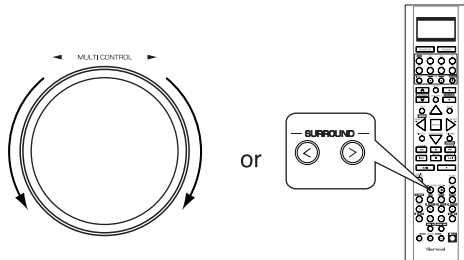

- Each time the MULTI CONTROL knob is rotated or the SURROUND MODE UP / DOWN (> / <) buttons are pressed, the surround mode changes depending on the input signal format as follows :

Signal format being input	Selectable surround mode
Dolby Digital EX 6.1 channel sources, Dolby Digital 5.1 channel sources	<DOLBY DIGITAL EX, DOLBY D + PLIIx MUSIC>, (DOLBY D + PLIIx MOVIE), DOLBY DIGITAL, DOLBY VS REF, DOLBY VS WIDE
Dolby Digital 2 channel sources	<DOLBY PLIIx MOVIE, DOLBY PLIIx MUSIC, DOLBY PLIIx GAME>, [DOLBY PLII MOVIE, DOLBY PLII MUSIC, DOLBY PLII GAME], DOLBY VS REF, DOLBY VS WIDE
DTS ES Discrete/Matrix 6.1 channel sources	<corresponding DTS ES mode, DTS + PLIIx MUSIC>, (DTS + PLIIx MOVIE), DTS, DOLBY VS REF, DOLBY VS WIDE
DTS sources, DTS 96/24 sources	correnponding DTS mode, DOLBY VS REF, DOLBY VS WIDE, <DTS + NEO:6, DTS + PLIIx MUSIC>, (DTS + PLIIx MOVIE)
PCM (mul i-channel) sources*	MULTI PCM, <DOLBY PLIIx MOVIE, DOLBY PLIIx MUSIC>, DOLBY VS REF, DOLBY VS WIDE
96 kHz PCM (2 channel) sources PCM (2 channel) sources, Analog stereo sources	<DOLBY PLIIx MOVIE, DOLBY PLIIx MUSIC, DOLBY PLIIx GAME>, [DOLBY PLII MOVIE, DOLBY PLII MUSIC, DOLBY PLII GAME], DOLBY VS REF, DOLBY VS WIDE, NEO:6 CINEMA, NEO:6 MUSIC, THEATER, HALL, STADIUM, ROOM, PANORAMA, CLASSIC, MULTI CH STEREO

- Depending on surround back speaker setting, some surround modes can be selected or not as follows:

< > : Possible only when surround back speaker is not set to "NO".

[] : Possible only when surround back speaker is set to "NO".

() : Possible only when surround back speaker is set to "2CH".

* : Depending on the signal format being input, the Dolby Pro Logic IIx modes and the Dolby Virtual Speaker modes may not be selected.

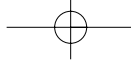

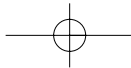

Continued

■ To cancel the surround mode for stereo operation

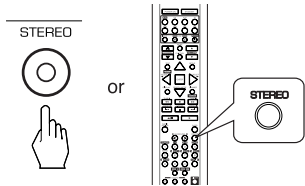

- Depending on the signal format which is being input, either the stereo mode or the 2CH downmix mode is selected.
- To cancel either the stereo mode or the 2CH downmix mode, select the surround mode with using the MULTI CONTROL knob on the front panel or the SURROUND MODE UP/DOWN (>/<) buttons on the remote control.

■ 2CH downmix mode

- This mode allows the multi-channel signals encoded in DTS or Dolby Digital format, etc. to be mixed down into 2 front channels and to be reproduced through only two front speakers or through headphones.
- When the SPEAKER button is set to off to listen with headphones, if the STEREO button is pressed while playing the multi-channel digital signals from DTS or Dolby Digital sources, etc., it will enter the 2CH downmix mode automatically.
- To cancel the 2CH downmix mode, select the Dolby Headphone mode with using the MULTI CONTROL knob on the front panel or the SURROUND MODE UP/DOWN (>/<) buttons on the remote control.

Listening in Dolby Headphone mode

- The Dolby Headphone function simulates 5.1 channel surround sound, which allows you to enjoy 5.1 channel surround sound through 2 channel headphones, just like listening from 5.1 channel speakers.

■ Note :

- Only when the SPEAKER button is set to off, the Dolby Headphone mode can be selected.
- Switch the speakers off to listen with headphones.



- Then "DOLBY HEADPHONE" (or "DOLBY H ~ ") is displayed and the Dolby Headphone mode is selected.
- To cancel the Dolby Headphone mode, press the SPEAKER button again.

Adjusting each channel level with test tone

- The volume level of each channel can be adjusted easily with the test tone function.
- Note : When the SPEAKER button is set to off, the test tone function does not work.

1. Enter the test tone mode.

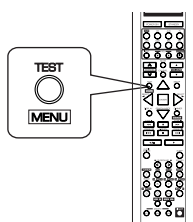

- The test tone will be heard from the speaker of each channel for 2 seconds as follows:

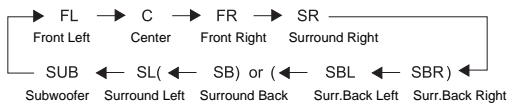

- When the speaker setting is "NO", the test tone of the corresponding channel is not available.
- () : Possible depending on whether the surround back channel is set to "2 CH" or "1 CH".

2. At each channel, adjust the level as desired until the sound level of each speaker is heard to be equally loud.

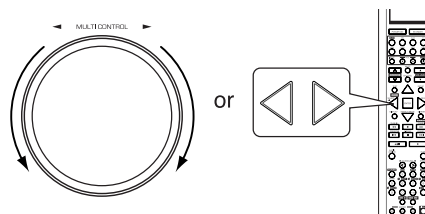

- You can select the desired channel with pressing the CONTROL UP/DOWN (▲/▼) buttons or the CURSOR UP/DOWN (▲/▼) buttons.

3. Cancel the test tone function.

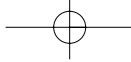
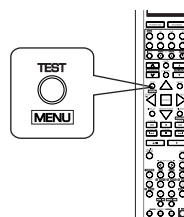

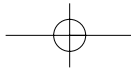

Adjusting the current channel level

- After adjusting each channel level with test tone, adjust the channel levels either according to the program sources or to suit your tastes.
- You can adjust the current channel levels as desired. These adjusted levels are just memorized into user's memory ("CAL"), not into preset memory("REF 1", "REF 2").

1. Press the CHANNEL LEVEL button.

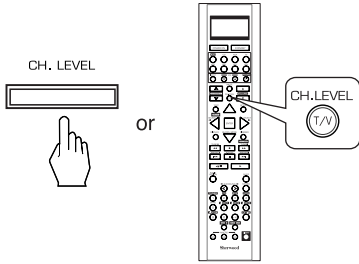

- Then the memory mode ("CAL" or "REF 1") is displayed for several seconds.
- When the memory mode or channel level disappears, press this button again.

2. Select the desired channel.

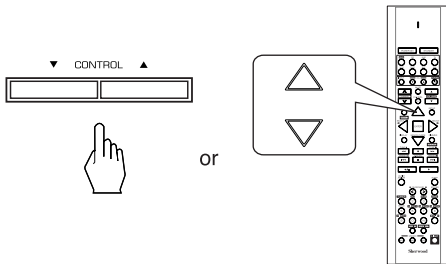

- Each time these buttons are pressed, the corresponding channel is selected as follows:

→ REF 1(or CAL) ↔ FL ↔ C ↔ FR ↔ SR ←
 < LFE > ↔ SUB ↔ SL(↔ SB) or (↔ SBL ↔ SBR) ←
DTS LFE or Dolby Digital LFE

- (): Possible depending on whether the surround back channel is set to "2 CH" or "1 CH".
- < >: Possible only when the digital signals from Dolby Digital or DTS program sources that include LFE signal are input.

- Depending on the speaker settings("NO", etc.) and surround mode, etc., some channels cannot be selected.
- When the SPEAKER button is set to off, only the Front Left, Front Right (and LFE) channels can be selected.

3. Adjust the level of the selected channel as desired.

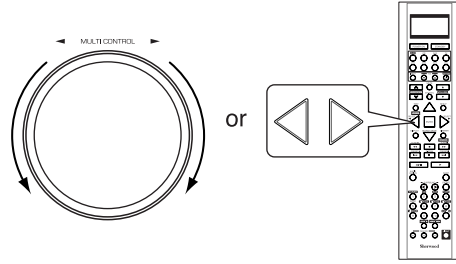

- The LFE level can be adjusted within the range of -10~0 dB and other channel levels within the range of -15~+15 dB.
- In general, we recommend the LFE level to be adjusted to 0 dB.(However, the recommended LFE level for some early DTS software is -10 dB.) If the recommended levels seem too high, lower the setting as necessary.

4. Repeat the above steps 2 and 3 to adjust each channel level.

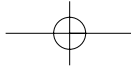

Memorizing the adjusted channel levels

- You can memorize the adjusted channel levels into preset memory("REF 1", "REF 2") and recall the memorized whenever you want.

- After performing the steps 1 ~ 4 in "Adjusting the current channel level" procedure on page 36, press the (MEMORY) ENTER button.

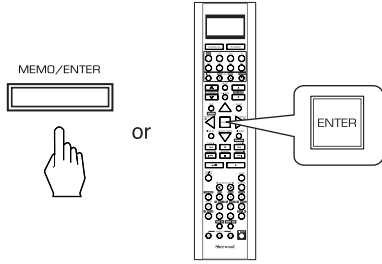

- The "1" of "REF 1" indication flickers for several seconds.

- Select the desired one of REF 1 and REF 2.

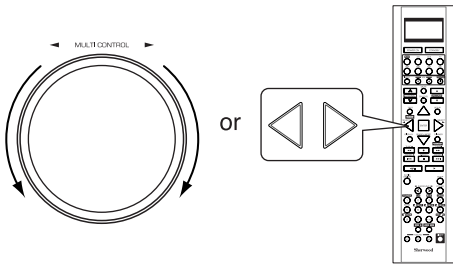

- If the preset memory disappears, perform the above step 1 again.

- Confirm your selection.

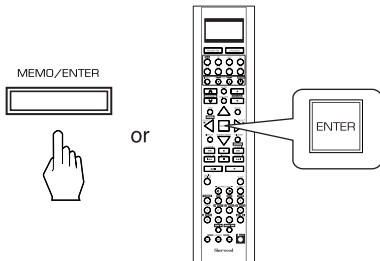

- The adjusted channel levels have now been memorized into the selected memory.

Recalling the memorized channel levels

- Press the CHANNEL LEVEL button.

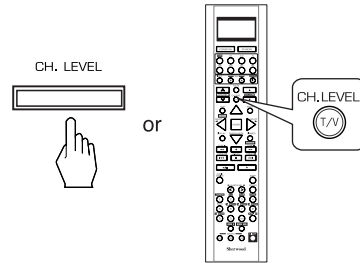

- "REF 1" (or "CAL") is displayed for several seconds.
- If the channel level mode display disappears, press this button again.

- Select the desired one of REF 1 and REF 2.

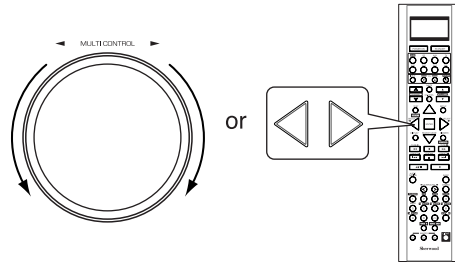

- Then the channel levels memorized into the selected preset memory are recalled.

LISTENING TO RADIO BROADCASTS

Auto tuning

1. Select the desired band.

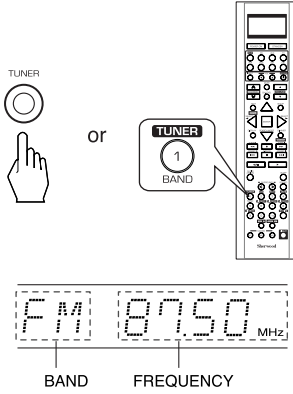

- Each time this button is pressed, the band changes as follows :

→ FM STereo → FM MONO → AM → XM
 ("ST" lights up) ("ST" goes off)

- When FM stereo broadcasts are poor because of weak broadcast signals, select the FM mono mode to reduce the noise, then FM broadcasts are reproduced in monaural sound.
- To listen to XM Satellite Radio, select XM mode. (For details, refer to "XM Satellite Radio (only for North America)" on page 40.)

2. Press the TUNING UP(+)/DOWN(-) buttons for more than 0.5 second.

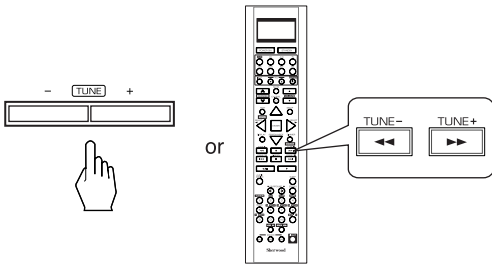

- The tuner will now search until a station of sufficient strength has been found. The display shows the tuned frequency and "TUNED".
- If the station found is not the desired one, simply repeat this operation.
- Weak stations are skipped during auto tuning.

Manual tuning

- Manual tuning is useful when you already know the frequency of the desired station.
- After selecting the desired band, press the TUNING UP(+) / DOWN(-) buttons repeatedly until the right frequency has been reached.

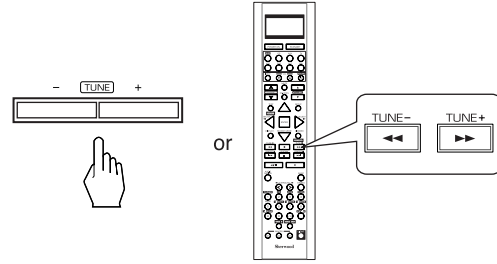

Auto presetting

- Auto presetting function automatically searches for FM stations only and store them in the memory.
- While listening to FM or AM radio broadcasts, press and hold down the MEMORY/ENTER button for more than 2 seconds.
- Then "AUTO MEM" flickers and this receiver starts auto presetting.
- Up to 30 FM stations can be stored.

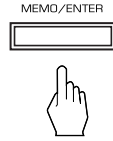

■ Notes:

- FM stations of weak strength cannot be memorized.
- To memorize AM stations or weak stations, preform "Manual presetting" procedure with using "Manual tuning" operation.

Manual presetting

- You can store up to 30 preferred stations in the memory.

1. Tune in the desired station with auto or manual tuning.

2. Press the MEMORY/ENTER button.

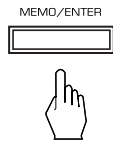

- "MEM" is flickering for several seconds.

3. Select the desired preset number (1~30) and press the MEMORY/ENTER button.

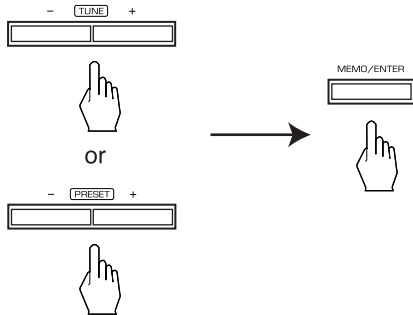

- The station has now been stored in the memory.
- A stored frequency is erased from the memory by storing another frequency in its place.
- If "MEM" goes off, start again from the above step 2.

4. Repeat the above steps 1 to 3 to memorize other stations.

■ MEMORY BACKUP FUNCTION

The following items, set before the receiver is turned off, are memorized.

- INPUT SELECTOR settings
- Surround mode settings
- Preset stations, etc.

Tuning to preset stations

- After selecting the tuner as an input source, select the desired preset number.

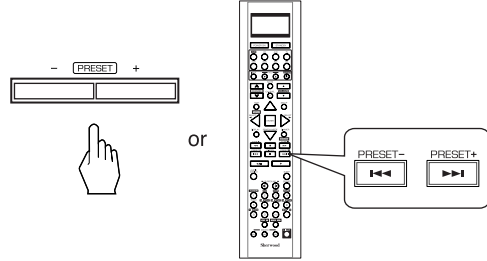

Scanning preset stations in sequence

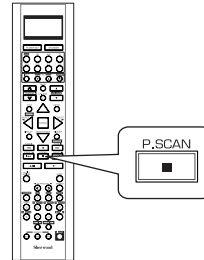

- The receiver will start scanning the stations in the preset sequence and each station is received for 5 seconds.
- At the desired station, press this button again to stop scanning.

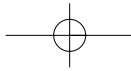

XM Satellite Radio (only for North America)

• This receiver is the XM Ready® receiver. You can receive XM Satellite Radio® by connecting to the XM Mini-Tuner system (sold separately) and subscribing to the XM service.

■ About XM Satellite Radio for U.S. & Canadian products

XM Satellite Radio offers an extraordinary variety of commercial-free music, plus the best in sports, news, talk and entertainment. XM is broadcast in superior digital audio from coast to coast. From rock to reggae, from classical to hip hop, XM has something for every music fan. XM's dedication to playing the richest selection of music is matched by its passion for live sporting events, talk radio, up-to-the-minute news, stand-up comedy, children's programming, and much more. For U.S. customers, information about XM Satellite Radio is available online at www.xmradio.com. For Canadian customers, information about XM Canada is online at www.xmradio.ca.

■ XM Ready® legal for U.S. & Canadian products

Hardware and required monthly subscription sold separately. Other fees and taxes, including a one-time activation fee may apply. Subscription fee is consumer only. All fees and programming subject to change. Channels with frequent explicit language are indicated with an XL. Channel blocking is available for XM radio receivers by calling 1-800-XMRADIO (US residents) and 1-877-GET-XMSR (Canadian residents). For a full listing of the XM commercial-free channels and advertising-supported channels, visit lineup.xmradio.com (US residents) or xmradio.ca (Canadian residents). Subscriptions subject to Customer Agreement available at xmradio.com (US residents) and xmradio.ca (Canadian residents). Only available in the 48 contiguous United States and Canada. ©2006 XM Satellite Radio Inc. All rights reserved. All other trademarks are the property of their respective owners.

■ XM Ready® subscriptions for U.S. Products & Canadian products

Once you have installed the XM Mini-Tuner Dock, inserted the XM Mini-Tuner, connected the XM Dock to your XM Ready® home audio system, and installed the antenna, you are ready to subscribe and begin receiving XM programming. There are three places to find your eight character XM Radio ID: on the XM Mini-Tuner, on the XM Mini-Tuner package, and on XM Channel 0. Record the Radio ID in the following eight squares for reference.

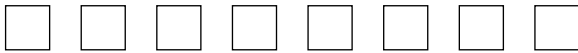

Note: The XM Radio ID does not use the letters "I", "O", "S" or "F". Activate your XM Satellite Radio service in the U.S. online at <http://activate.xmradio.com> or call 1-800-XM-RADIO (1-800-967-2346). You will need a major credit card. XM will send a signal from the satellites to activate the full channel lineup. Activation normally takes 10 to 15 minutes, but during peak busy periods you may need to keep your XM Ready home audio system on for up to an hour. When you can access the full channel lineup on your XM Ready home audio system you are done. For more information or to subscribe in Canada, visit XM on the Web at www.xmradio.ca or call XM's Listener Care at 1-877-GET-XMSR (1-877-438-9677).

LISTENING TO XM SATELLITE RADIO

Signing up for XM Satellite Radio

• Before using XM Satellite Radio, you must first sign up for an account. You will need a major credit card and your XM Satellite Radio ID, which you can get from this receiver as explained below.

1. Press the TUNER button repeatedly to select XM mode.

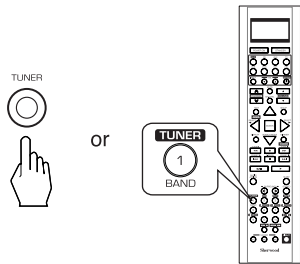

• Then "XM ~" is displayed.

2. Press the TUNING UP(+)/DOWN(-) buttons repeatedly to select "XM 000".

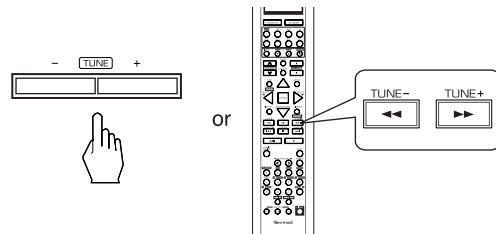

• Then your XM Satellite Radio ID is displayed.
• You can find the XM Satellite Radio ID on the XM Mini-Tuner itself and the XM Mini-Tuner package, too.

3. To sign up, access the website at "<http://activate.xmradio.com>" or call "1-800-967-2346".

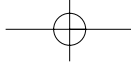

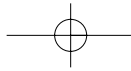

Channel search

- In the XM mode, press the TUNING UP (+)/DOWN (-) buttons repeatedly to select the desired channel.

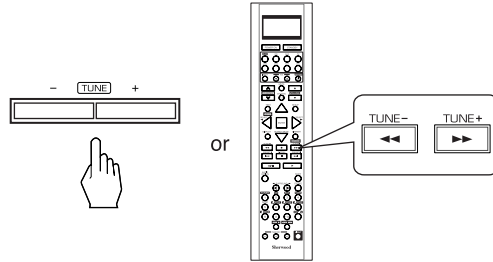

ENGLISH

Direct search

- Direct search is useful when you already know the channel number.

1. In the XM mode, select the direct search mode.

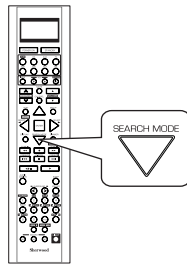

- Each time this button is pressed, the search mode changes as follows:

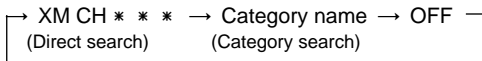

- Note:
- When using channel search or preset search, press this button to select the search off.

Category search

- Category search allows you to select the desired channel by the selected category.

1. In the XM mode, select the category search mode.

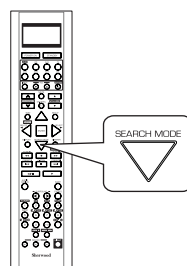

- Then a category name is displayed.

2. While displaying "XM CH * * *", select the desired channel number with pressing the NUMERIC (0 ~ 9) buttons.

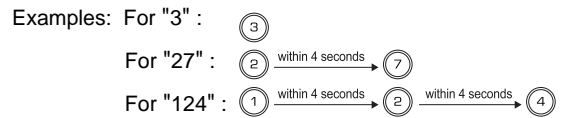

- When "XM CH * * *" disappears, repeat again from the above step 1.

2. While displaying a category name, select the desired category, then press the ENTER button.

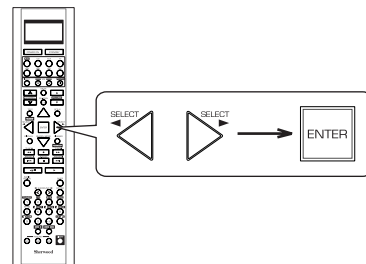

- Each time these buttons are pressed, one of different categories is selected.
- When a category name disappears, repeat again from the above step 1.

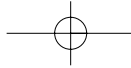

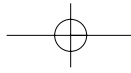

Continued

3. While displaying the selected category, select the desired channel.

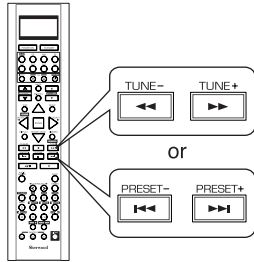

Presetting channels

You can store up to 30 preferred channels in the memory.

1. Select the desired channel with preforming channel search, direct search or category search.

2. To memorize the channels, perform the steps 2 to 4 in "Manual presetting" procedure on page 39.

Preset search

In the XM mode, select the desired preset channel.

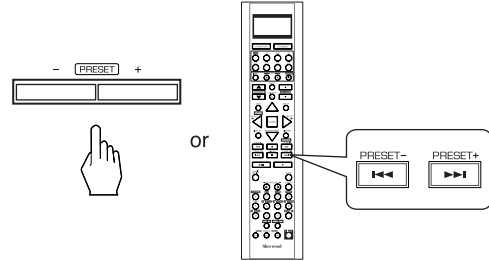

Displaying XM information

You can display XM information such as channel name, artist name, song title and signal strength.

In the XM mode,

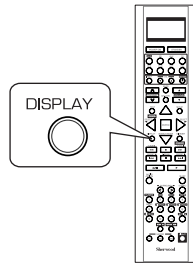

Note:

If the information on artist name, song title or category is not available, it will not be displayed correctly.

Signal strength display mode

If the reception is poor, you can check the signal strength of the XM radio signal and adjust the position of the XM antenna until "GOOD" is displayed.

Each time the DISPLAY button is pressed, the display mode changes as follows:

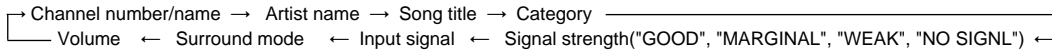

Error message and status

If an operation takes longer than usual or an error occurs, one of the following messages may be displayed.

Message	Status
ANTENNA	The XM antenna is not connected correctly. Check the antenna.
UPDATING	The XM user encryption code is being updated. Please wait.
NO SIGNL	The signal is too weak. Check the antenna connection and reposition it for the best reception.
LOADING	This receiver is tuning or decoding audio or text data. Please wait.
OFF AIR	The selected XM channel is not currently broadcasting. Select another channel.

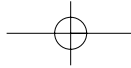

OTHER FUNCTIONS

Operating the sleep timer

- The sleep timer allows the system to continue to operate for a specified period of time before automatically shutting off.
- To set the receiver to automatically turn off after the specified period of time.

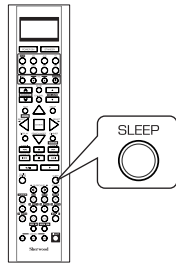

- Each time this button is pressed, the sleep time changes as follows:

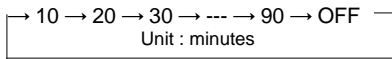

- While operating the sleep timer, " ★ " lights up.

Adjusting the brightness of the fluorescent display

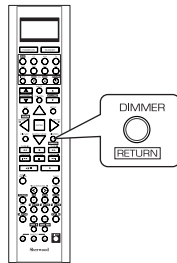

- Each time this button is pressed, the brightness of the fluorescent display changes as follows:

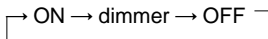

- In the display OFF mode, pressing any button will cancel the display OFF mode.

Displaying the audio information

- You can check the audio information on the input source.
- During playback,

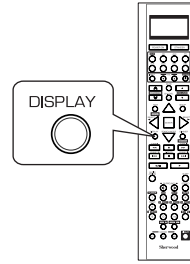

- Each time this button is pressed, the display mode changes as follows :

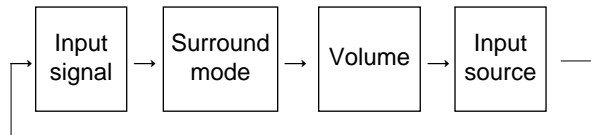

- When the EXTERNAL IN is selected as an input source, the surround mode is not displayed.
- When XM satellite radio function is available in your country, for details on the XM information, see "Displaying XM information" on page 42.

ROOM 2 SOURCE PLAYBACK

- This function allows enjoying one source in the main room and playing another in a different room at the same time.
- When you connect the multi-room system kit to the IR IN jack of this receiver, you can control this receiver with not only the universal remote control unit but also the ROOM 2 remote control unit in a different room, too. (For details, refer to "CONNECTING MULTI-ROOM SYSTEM KIT" on page 13 and "ROOM 2 Remote Controls" on page 29.)

■ Notes:

- The analog signals from the EXTERNAL INs and the digital signals cannot be output to the different room, meaning no playback in a different room.
- You cannot play the ROOM 2 source in any surround mode.

- When using the buttons on the remote control unit.

1. Press the ROOM 2 button.

- ROOM 2 ~ is displayed for several seconds.
- Each time this button is pressed, the ROOM 2 mode changes as follows :
OFF : To turn off the ROOM 2 function. ("R2" goes off.)
↓
ON : To turn it on. ("R2" lights up.)

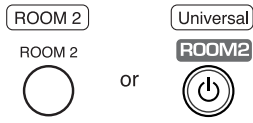

■ Note :

- When the ROOM 2 mode is set to OFF, you cannot adjust the ROOM 2 volume.

2. Select the desired input as a ROOM 2 source.

- Each time the INPUT button on the universal remote control unit is pressed, the ROOM 2 input can be selected among MAIN source, TUNER, CD, AUX, TAPE, VIDEO 1 ~ VIDEO 4.

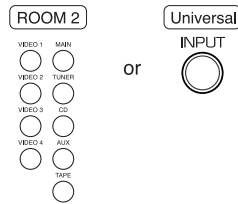

3. Adjust the ROOM 2 volume.

- You can adjust the volume on the power amplifier assigned to "BACK ← → ROOM 2" or "ROOM 2" when the ROOM 2 speaker terminals are connected to the speakers in a different room. (For details, refer to "When selecting the AMP ASSIGN" on page 49.)
- The MUTE button on the ROOM 2 remote control unit can be available only when the ROOM 2 function is operating.

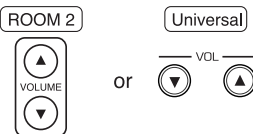

4. Start play on the component related to the ROOM 2 source.

■ Notes:

- When the EXTERNAL IN is selected as a main input, if the MAIN source is selected as a ROOM 2 input, no audio signal can be heard in the different room (ROOM 2).
- Even when this receiver enters the standby mode, in such a case that "R2" lights up still and the POWER ON/STANDBY button lights up blue as it does in the operating mode, meaning only the ROOM 2 circuitry operates, the ROOM 2 source can be played independently.
- When you do not use the ROOM 2 function, turn off the ROOM 2 function, or off the ROOM 2 function to save electricity.

- When using the buttons on the front panel.

1. Press the ROOM 2 button to enter the ROOM 2 mode.

- ROOM 2 ~ is displayed for several seconds.
- When the ROOM 2 setting mode disappears, press the ROOM 2 button again.

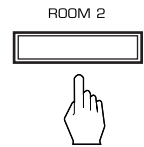

2. Select the desired mode while displaying the ROOM 2 setting mode.

- Each time these buttons are pressed, the mode changes as follows :

ROOM 2 ~ : To turn on or (ROOM 2 mode) off the ROOM 2 function.
↓
IN ~ : To select the desired ROOM 2 source. (ROOM 2 input)

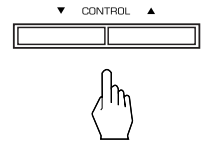

VOL ~ : To adjust the volume on the power (ROOM 2 volume) amplifier assigned to "BACK ← → ROOM 2" or "ROOM 2".

- Note : When the ROOM 2 mode is set to OFF, the ROOM 2 input and the ROOM 2 volume cannot be selected

3. Set the selected mode as desired.

- When selecting the ROOM 2 mode.
OFF : To turn off the ROOM 2 function. ("R2" goes off.)
↓
ON : To turn it on. ("R2" lights up.)
- When selecting the ROOM 2 input.
- You can select the desired among MAIN source, TUNER, CD, AUX, TAPE, VIDEO 1 ~ VIDEO 4 as a ROOM 2 source.
- When selecting the ROOM 2 volume.
- You can adjust the volume on the power amplifier assigned to "BACK ← → ROOM 2" or "ROOM 2" when the ROOM 2 speaker terminals are connected to the speakers in a different room. (For details, refer to "When selecting the AMP ASSIGN" on page 49.)

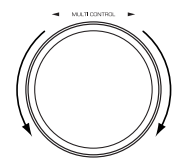

4. Start play on the component related to the ROOM 2 source.

RECORDING

- The analog signals from the EXTERNAL INs as well as the digital signals from the coaxial or optical digital input can be heard but cannot be recorded.
- When recording the analog signals from CD, AUX, VIDEO 1 ~ 4, be sure to select the "ANALOG" for the AUDIO MODE. (For details, refer to "When selecting the AUDIO MODE" on page 54.)
- The volume and tone (bass, treble) settings have no effect on the recording signals.

Recording with TAPE

- To record the analog signals onto the recording equipment, be sure to connect the ROOM2 OUT jacks to the recording equipment. (For details, refer to "CONNECTING AUDIO COMPONENTS" on page 8.)

1. Select the desired input as a recording source except for TAPE.

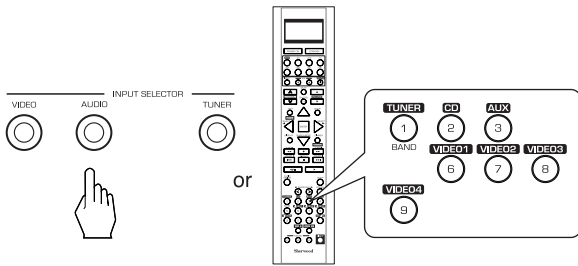

2. Turn on the ROOM 2.

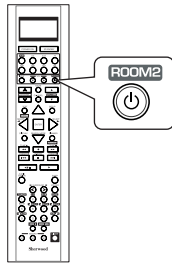

3. Select the MAIN as a ROOM 2 input.

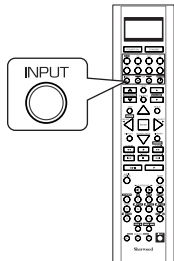

4. Start recording on the TAPE.

5. Start play on the desired input.

Dubbing the audio and video signals separately onto VIDEO 1

Example: When dubbing the VIDEO 2 video signal and the CD audio signal separately onto VIDEO 1.

1. Select VIDEO 2 as a video recording source.

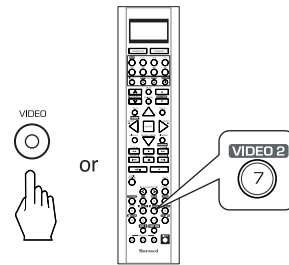

2. Select CD as an audio recording source.

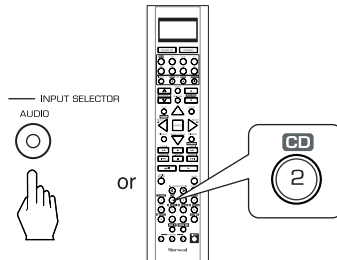

3. Start recording on the VIDEO 1.

4. Start play on the VIDEO 2 and the CD respectively.

- The audio signal from the CD and the video signal from the VIDEO 2 will be dubbed and you can enjoy them on the TV set and from the speakers.

■ **Note** : Be sure to observe the order of the above steps 1 and 2.

Dubbing from video components onto VIDEO 1

1. Select the desired of VIDEO 2 ~ 4 as a recording source except VIDEO 1.

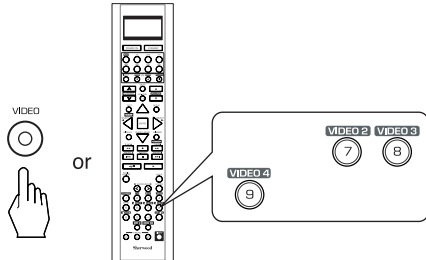

2. Start recording on the VIDEO 1.

3. Start play on the desired input.

- The audio and video signals from the desired input will be dubbed onto the VIDEO 1 and you can enjoy them on the TV set and from the speakers.

DIGITAL AUDIO RECORDING WITH MD RECORDER

- Only when the OPTICAL DIGITAL OUT of this receiver is connected to the OPTICAL DIGITAL IN of the MD recorder or CD recorder, you can enjoy high-quality sound of digital recording without converting the original signals. Refer to "CONNECTING VIDEO COMPONENTS", "CONNECTING AUDIO COMPONENTS" and "CONNECTING DIGITAL INS and OUT" on pages 6~9 and the operating instructions of the MD recorder or CD recorder.

Notes:

- Depending on the digital audio signal format input into the HDMI IN connector, some digital signals cannot be output from the OPTICAL DIGITAL OUT jack.
- Digital recording is available for the digital audio program sources such as CDs, MDs, some DVDs, etc.
- In most DVDs and SACDs as well as some CDs, etc., digital recording may not be available depending on the signal format.
- There are some restrictions on recording digital signals. When making digital recordings, refer to the operating instructions of your digital recording equipment to know what restrictions are imposed.

1. Select the desired of CD, AUX, VIDEO 1~4 as a recording source.

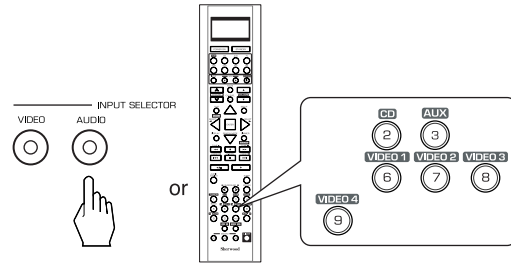

In case of recording the digital audio signal input into a HDMI IN connector

- Select the desired recording source to which the HDMI IN is connected and assigned and then perform the steps 3 and 4 (, but ignore the step 2).

Note :

- If the AUDIO MODE is set to the mode other than "HDMI" for the corresponding recording source on the INPUT SETUP menu, the digital audio signals will not be output and there will be no recording. (For details, refer to "When selecting the AUDIO MODE" on page 54.)

2. For digital recording, select the digital input as recording signal input.

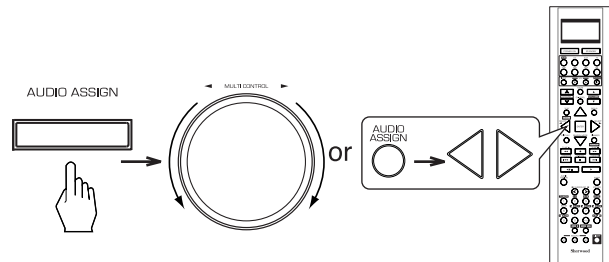

Note :

- If the AUDIO MODE is set to the mode other than "DIGITAL" for the corresponding recording source on the INPUT SETUP menu, the digital audio signals from the selected digital input will not be output and there will be no recording. (For details, refer to "When CD, AUX, VIDEO 1~ 4 is selected as an input source" on page 31 and "When selecting the AUDIO MODE" on page 54.)

3. Start recording on the component connected to the OPTICAL DIGITAL OUT.

4. Start play on the desired input.

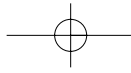

OSD Menu Settings

- The OSD (On-Screen Display) menu is a setting menu that is displayed on the monitor TV and allows you to perform the setup procedures easily. In most situations, you will only need to set this once during the installation and layout of your home theater, and it rarely needs to be changed later.

The OSD menu consists of 6 main menus ; system setup, input setup, speaker / room EQ setup, CH level setup, sound parameter and multi room setup. These menus are then divided up into various sub-menus.

■ Notes:

- The OSD menu and the momentary OSD cannot be displayed via the HDMI MONITOR OUT connector.
- Depending on the VIDEO MODE setting and the video connections between this receiver and the video component, the OSD menu and the momentary OSD cannot be displayed via (COMPOSITE) VIDEO MONITOR OUT jack, or the picture is automatically turned off and only the OSD menu can be displayed via COMPONENT MONITOR OUT jacks. (For details, refer to "Relationship between the video input signal and the video output signal" on page 7.)

■ Navigating through the OSD menu

- The explanations here assume you are using the buttons on the remote control when performing the OSD menu operation. However, you can use the buttons on the front panel as well.

The buttons on the front panel correspond to those on the remote control as shown below.

Button on the remote control				
Button on the front panel				

1. Turn the menu screen on.

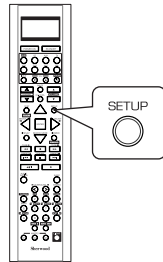

MAIN MENU	
> SYSTEM	SETUP
INPUT	SETUP
SPEAKER	
/ROOM EQ	SETUP
CH LEVEL	SETUP
SOUND	PARAMETER
MULTI ROOM	SETUP
EXIT	

- The main menu will be shown.
- To turn the menu screen off, press this button again.

2. Select the desired menu using the CURSOR UP(▲)/DOWN(▼) buttons.

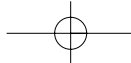
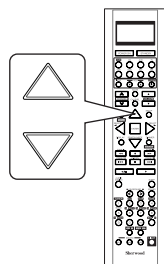

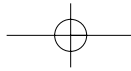

3. Confirm your selection.

ENGLISH

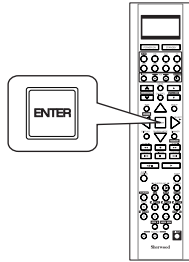

■ When selecting the SYSTEM SETUP

```

SYSTEM SETUP
>AMP ASSIGN : BACK←→ROOM2
SUB W MODE : NORMAL
HDMI AUDIO OUT : OFF
TONE CONTROL : OFF
CINEMA EQ : OFF
BACKGROUND : BLACK
MOMENTARY OSD : ON
OSD POSITION ADJUST
RETURN TO MAIN MENU
    
```



■ When selecting the INPUT SETUP

```

INPUT SETUP
>VIDEO 1 CONFIG
VIDEO 2 CONFIG
VIDEO 3 CONFIG
VIDEO 4 CONFIG
CD CONFIG
TAPE CONFIG
AUX CONFIG
TUNER CONFIG
EXT. IN CONFIG
RETURN TO MAIN MENU
    
```



■ When selecting the SPEAKER/ROOM EQ SETUP

```

SPEAKER/R. EQ SETUP
>AUTO SETUP
SPEAKER CONFIG
SPEAKER DISTANCE
SPEAKER CROSSOVER
ROOM EQ SETUP
RETURN TO MAIN MENU
    
```



■ When selecting the CH LEVEL SETUP

```

CH LEVEL SETUP
>MODE : CALIBRATE
FRONT LEFT : 0dB
CENTER : 0dB
FRONT RIGHT : 0dB
SURR RIGHT : 0dB
BACK/MULTI R : 0dB
BACK/MULTI L : 0dB
SURR LEFT : 0dB
SUBWOOFER : 0dB
LFE LEVEL SETUP
RETURN TO MAIN MENU
    
```



■ When selecting the SOUND PARAMETER

```

SOUND PARAMETER
>NIGHT MODE
DOLBY PLII MUSIC
DOLBY HEADPHONE
DOLBY VIRTUAL SPEAKER
RETURN TO MAIN MENU
    
```



■ When selecting the MULTI ROOM SETUP

```

MULTI ROOM SETUP
>ROOM 2 : OFF
INPUT : MAIN
VOLUME : ---
RETURN TO MAIN MENU
    
```



- For the setting details, see page in ⇔
- Adjust the setting(s) in each setting category to your preference.
- When the SETUP button is pressed on a sub-menu, the menu screen will be turned off.

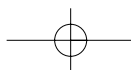

SETTING THE SYSTEM SETUP

SYSTEM SETUP
 >AMP ASSIGN : BACK←→ROOM2
 SUB W MODE : NORMAL
 HDMI AUDIO OUT : OFF
 TONE CONTROL : OFF
 CINEMA EQ : OFF
 BACKGROUND : BLACK
 MOMENTARY OSD : ON
 OSD POSITION ADJUST
 RETURN TO MAIN MENU

- AMP ASSIGN : To assign the surround back channels' power amplifier correctly depending on how to use the speakers.
- SUBWOOFER MODE : To select the desired subwoofer mode.
- HDMI AUDIO OUT : To output the digital audio signals from the HDMI MONITOR OUT connector.
- TONE CONTROL : To adjust the tone (bass and treble) as desired.
- CINEMA EQ : To select the desired cinema EQ mode.
- BACKGROUND : To select the desired background color of the momentary OSD and the OSD menu.
- MOMENTARY OSD : To turn on or off the OSD that shows the status corresponding to each operation momentarily.
- OSD POSITION ADJUST : To adjust the position of the momentary OSD and the OSD menu.

When selecting the items other than OSD POSITION ADJUST

1. Press the CURSOR UP(▲)/DOWN(▼) buttons to select the desired item.

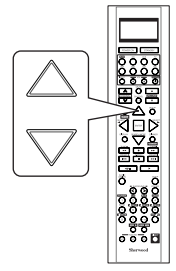

2. Press the CURSOR LEFT(◀)/RIGHT(▶) buttons to set the selected item as desired.

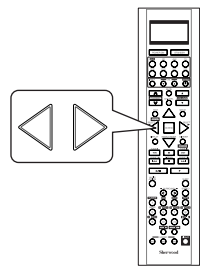

When selecting the AMP ASSIGN

- The surround back channels' power amplifier can drive the surround back speakers, the ROOM 2 speakers or the front bi-amp capable speakers. Depending on how to use the speakers, you should assign the power amplifier correctly. (For details, refer to "CONNECTING SPEAKERS" on page 10 and "CONNECTING ROOM 2 OUTS" on page 12.)

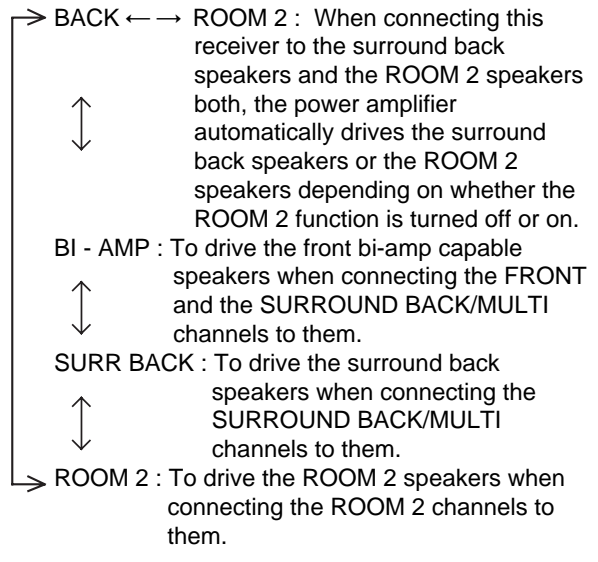

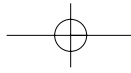

Continued

When selecting the SUBWOOFER MODE

ENGLISH

- "SW PLUS +" mode is valid only when "FRONT" and "CENTER" are set to "FULL RANGE" and "SUBWOOFER" is set to "YES" on the SPEAKER/ROOM EQ SETUP menu. (For details, refer to "SETTING THE SPEAKER/ ROOM EQ SETUP" on page 57.)

NORMAL : When the low frequency signals of channels set to "FULL RANGE" are reproduced from those channels only. In this mode, the low frequency signals that are reproduced from the subwoofer channel is only the low frequency signals of LFE (from the multi-channel sources that contains LFE (Low Frequency Effects) channel, also called the ".1" channel) and the channels set to the setting value other than "FULL RANGE".



SW PLUS + : When the low frequency signals of channels set to "FULL RANGE" are reproduced simultaneously from those channels and the subwoofer channel. In this mode, the low frequency range expands more uniformly through the room, but depending on the size and shape of the room, interference may result in a decrease of the actual volume of the low frequency range.

When selecting the HDMI AUDIO OUT

- The HDMI connection can carry uncompressed digital video signals and digital audio signals. Depending on whether these digital audio signals are output from the HDMI MONITOR OUT of this receiver or not, you should set the HDMI AUDIO OUT correctly.

OFF : Not to output the digital audio signals from the HDMI MONITOR OUT of this receiver, meaning these signals are heard from the speakers connected to this receiver.



ON : To output the digital audio signals, meaning these signals are heard from the speakers of your TV.

■ Notes:

- When the HDMI AUDIO OUT is set to ON, no sound will be heard from the speakers connected to this receiver (except ROOM 2 speakers) even though any input source is selected.
- If your TV cannot support some digital audio formats, no sound may be heard from its speakers even when the HDMI AUDIO OUT is set to ON.

When selecting the TONE CONTROL

OFF : To listen to a program source without the tone effect. ("DIRECT" indicator lights up.)



ON : To adjust the tone for your taste. ("DIRECT" indicator goes off.)

- When the TONE CONTROL is set to ON to adjust the tone (bass and treble)

①. Press the ENTER button to enter the tone adjustment mode.

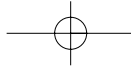
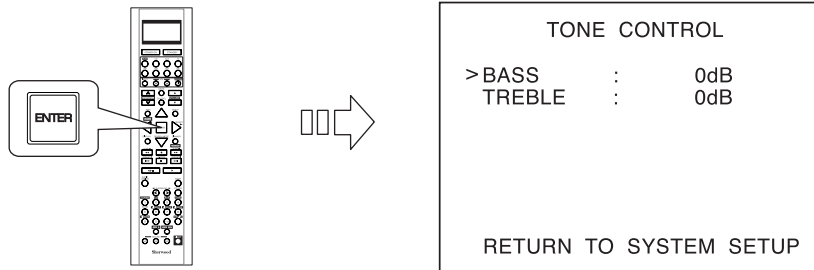

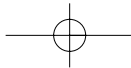

Continued

- ②. Press the CURSOR UP(▲)/DOWN(▼) buttons to select the desired tone mode.

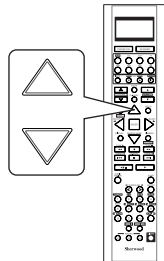

- ③. Press the CURSOR LEFT(◀)/RIGHT(▶) buttons to adjust the selected tone as desired.

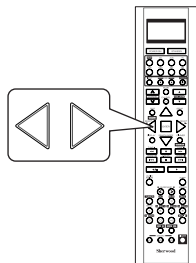

- The tone level can be adjusted within the range of -10 ~ +10 dB.
- In general, we recommend the bass and treble to be adjusted to 0 dB (flat level).
- Extreme settings at high volume may damage your speakers.
- To complete tone adjustment, repeat the above steps ② and ③.

When selecting the CINEMA EQ

OFF : To turn off the cinema EQ function.



ON : To compensate for edgy or shrill movie sound tracks.

When selecting the BACKGROUND

BLACK : To display the black as the color background of the momentary OSD and the OSD menu.



BLUE : To display the blue.

- **Note** : Only when no video signals are input into this unit, the selected background color will be displayed.

When selecting the MOMENTARY OSD

ON : To turn on the OSD function that shows the status corresponding to each operation on this unit

↑ momentarily.

OFF : To turn it off.

- **Note** : When outputting the component video signal from the COMPONENT MONITOR OUT jacks as it was input, the momentary OSD cannot be displayed.

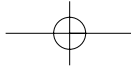

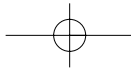

When selecting the OSD POSITION ADJUST

- You can adjust the position of the momentary OSD and the OSD menu that are displayed on the monitor TV.

ENGLISH

1. Press the CURSOR UP(▲)/DOWN(▼) buttons to select the OSD POSITION ADJUST, then press the ENTER button.

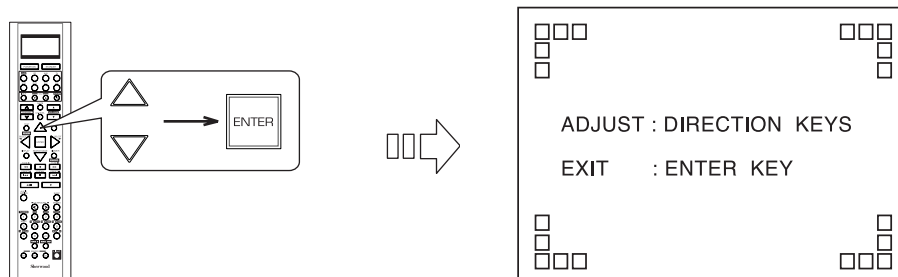

2. Press the CURSOR UP(▲)/DOWN(▼)/LEFT(◀)/RIGHT(▶) buttons to adjust the position of the momentary OSD and the OSD menu as desired.

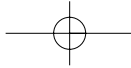
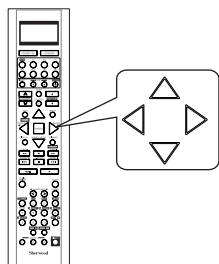

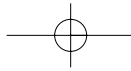

SETTING THE INPUT SETUP

INPUT SETUP	
>VIDEO 1	CONFIG
VIDEO 2	CONFIG
VIDEO 3	CONFIG
VIDEO 4	CONFIG
CD	CONFIG
TAPE	CONFIG
AUX	CONFIG
TUNER	CONFIG
EXT . IN	CONFIG
RETURN TO MAIN MENU	

- This menu allows you to make the various settings depending on how to use the input sources connected to this receiver.

When selecting the items other than NAME

1. Press the CURSOR UP(▲)/DOWN(▼) buttons to select the desired input source, then press the ENTER button.

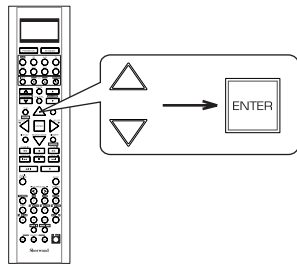

Example: When selecting the VIDEO 1

VIDEO 1 CONFIG	
>NAME	: VIDEO 1
HDMI ASSIGN	: HDMI 1
VIDEO ASSIGN	: COMP 1
VIDEO MODE	: AUTO
AUDIO ASSIGN	: OPT 1
AUDIO MODE	: AUTO

Page 1



■ When selecting the menu of page 2 or page 1.

- Press the CURSOR UP(▲)/DOWN(▼) buttons to select "GO TO NEXT ~", then press the ENTER button.

AUTO SURROUND	: OFF
AUD REMASTER	: OFF
AV SYNC.	: 0 ms
DC TRIGGER	: OFF

Page 2

2. Press the CURSOR UP(▲)/DOWN(▼) buttons to select the desired item.

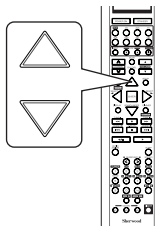

■ Note :

- Depending on the input source, some items other than DC TRIGGER cannot be selected.

3. Press the CURSOR LEFT(◀)/RIGHT(▶) buttons to set the selected item as desired.

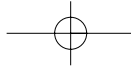
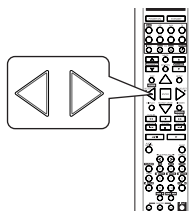

Continued**When selecting the HDMI ASSIGN**

- You should assign the connected HDMI INs to the desired of VIDEO 1 ~ VIDEO 4.
(For details, refer to "CONNECTING VIDEO COMPONENTS" on pages 6 ~ 7.)
- You can select HDMI 1 or HDMI 2.
 - **Note :**
 - In such a case that a HDMI IN is assigned to two input sources or more, when these input sources are selected, the uncompressed digital video signals (and digital audio signals when the HDMI AUDIO OUT is set to ON) input into the same HDMI IN can be output from the HDMI MONITOR OUT of this receiver.

When selecting the VIDEO ASSIGN

- You should assign the connected COMPONENT VIDEO INs to the desired of VIDEO 1 ~ 4.
(For details, refer to "CONNECTING VIDEO COMPONENTS" on pages 6 ~ 7.)
- You can select the desired of COMP 1 ~ 2.
 - **Note :**
 - In such a case that a COMPONENT VIDEO IN is assigned to two input sources or more, when these input sources are selected, the component video signals can be viewed from the same COMPONENT VIDEO IN.

When selecting the VIDEO MODE

- You can select the video input signal to be output from the MONITOR OUTs.
 - AUTO : When there are multiple video input signals, the video input signals are detected and the video input signal to be output from the MONITOR OUTs is selected automatically in the following order :
component video, S-video, composite video.
 - ↕
 - COMPOSITE : The signal that is input into the (COMPOSITE) VIDEO jack is always played. The composite video input signal is up-converted and output from the S-VIDEO and COMPONENT MONITOR OUT jacks.
 - ↕
 - S-VIDEO : The signal that is input into the S-VIDEO jack is always played. The S-Video input signal is converted and output from the (COMPOSITE) VIDEO and COMPONENT MONITOR OUT jacks.
 - ↕
 - COMPONENT : The signals that are input into the COMPONENT jacks are always played.
Because video conversion is not performed, no video signals are output from the MONITOR OUT jacks when there are no video signals that are input into the COMPONENT jacks.
- For details, refer to "Relationship between the video input signal and the video output signal" on page 7.
 - **Note :**
 - When selecting the VIDEO 4, S-VIDEO cannot be selected.

When selecting the AUDIO ASSIGN

- You should assign the connected DIGITAL INs to the desired of CD, AUX and VIDEO 1 ~ VIDEO 4.
(For details, refer to "CONNECTING DIGITAL INs AND OUT" on page 9.)
- You can select the desired of OPT 1, OPT 2, COAX1 and COAX 2.
 - **Note :**
 - In such a case that a DIGITAL IN is assigned to two input sources or more, when these input sources are selected, the digital audio signals can be heard from the same DIGITAL IN.

When selecting the AUDIO MODE

- You can select the desired audio input signal to be played.
 - **Notes :**
 - Be sure to set the AUDIO MODE to the audio input which is connected and assigned to the selected input source.
 - When the HDMI AUDIO OUT is set to ON, no sound will be heard from the speakers connected to this receiver (except ROOM 2 speakers).
 - When the AUDIO MODE is set to HDMI, you should set the HDMI ASSIGN correctly. If not, "H1", "H2" (, meaning no digital audio signal input from it) or "Hd" (, meaning no HDMI assignment) flickers on the unit's display and no sound will be heard.
 - When the AUDIO MODE is set to DIGITAL, you should set the AUDIO ASSIGN correctly. If not, "o1", "c1", etc.(, meaning no digital signal input from it) or "d" (, meaning no audio assignment) flickers on the unit's display and no sound will be heard.
- AUTO : When there are multiple audio input signals, the audio input signals are detected and the audio input signal to be played is selected automatically in the priority order of them :
HDMI audio > DIGITAL audio > ANALOG audio
- ↕
- HDMI : The signal that is input into the HDMI IN is always played.
- ↕
- DIGITAL : The signal that is input into the OPTICAL or the COAXIAL DIGITAL IN is always played.
- ↕
- ANALOG : The signal that is input into the analog AUDIO INs is always played.

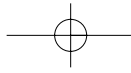

Continued

When selecting the AUTO SURROUND

- Depending on how to select a surround mode, you can select the auto surround mode or the manual surround mode.

ON : The optimum surround mode will be automatically selected depending on the signal format being input.
(Auto surround mode)



OFF : You can select the desired of different surround modes selectable for the signal being input with using the MULTI CONTROL knob or the SURROUND MODE UP/DOWN (>/<) buttons. (For details, refer to "When selecting the manual surround mode with pressing the SURROUND MODE button on the front panel" on page 34.)
(Manual surround mode)

■ **Notes :**

- Even when the auto surround mode is selected and the same type of digital signal format is being input, the optimum surround mode may vary depending on whether the speaker type is set to "NO" or not.
- When the auto surround mode is selected, the surround modes other than the optimum surround mode cannot be selected.

When selecting the AUDIO REMASTER

- The remastering processes the input signal digitally and converts its digital sampling frequency to twice the current frequency (88.2/96 kHz) for a more detailed sound reproduction.

ON : To process the input signal digitally and to convert its sampling frequency to 88.2/96 kHz for a more detailed sound reproduction.



OFF : To turn off the remastering function.

■ **Note :**

- The remastering function have no effect on the input digital signal from the 88.2/96 kHz source or higher as well as the digital signal that is output from the OPTICAL DIGITAL OUT of this receiver.

When selecting the AV SYNC

- There may be a slight time delay between the video and audio signals in case that some video playback equipments may process the video signals later than the audio signals due to signal processing procedure, etc.. Should this happen, you can adjust the time delay of audio signals to synchronize the sound with the picture.
- The time delay can be adjusted within the range of 0 ~ 200 msec.

When selecting the DC TRIGGER

- To turn on the component connected to the DC TRIGGER OUT jack when this input source is selected, you should set the DC TRIGGER to ON for this input source.

OFF : To turn off the DC trigger function.



ON: To turn it on.

- For details, refer to "CONNECTING DC TRIGGER OUT" on page 9.

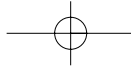

ENGLISH

When selecting the NAME

- You can give names to the input sources other than tuner.
- Up to 7 characters can be entered for each name.

1. Press the CURSOR UP(▲)/DOWN(▼) buttons to select the desired input source, then press the ENTER button.

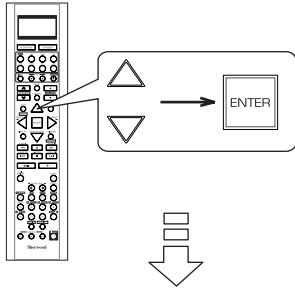

Example: When selecting the VIDEO 1

```

VIDEO 1  CONFIG
>NAME    : VIDEO 1
HDMI ASSIGN : HDMI 1
VIDEO ASSIGN : COMP 1
VIDEO MODE : AUTO
AUDIO ASSIGN : OPT 1
AUDIO MODE  : AUTO
    
```

2. Press the CURSOR UP(▲)/DOWN(▼) buttons to select the NAME, then press the ENTER button.

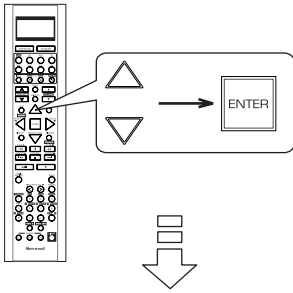

```

VIDEO 1  CONFIG
>NAME    : VIDEO 1
    
```

- The first digit flickers.

3. Press the CURSOR LEFT(◀)/RIGHT(▶) buttons to select the desired digit.

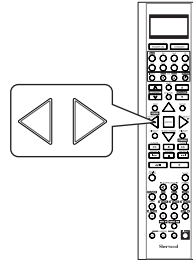

- Then the selected digit will flicker.

4. Press the CURSOR UP(▲)/DOWN(▼) buttons to enter the desired character on the flickering digit.

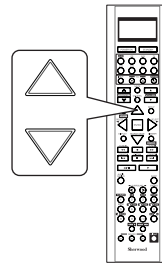

- You can enter the desired among blank, A ~ Z, a ~ z, 0 ~ 9, (,), *, +, ,, -, ., /.

5. Repeat the above steps 3 and 4 to enter the desired characters on the rest of the digits.

6. Confirm your entry.

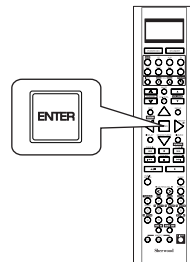

- The name is stored in the memory.

- **To resume its factory input source name.**
- Make a blank on each digit and press the ENTER button.

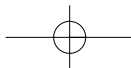

SETTING THE SPEAKER / ROOM EQ SETUP

- After you have installed this receiver and connected all the components, you should adjust the speaker settings for the optimum sound acoustics according to your environment and speaker layout.
- Even when you change speakers, speaker positions, or the layout of your listening environment, you should adjust the speaker settings, too.
- When performing the AUTO SETUP procedure, you need not perform the SPEAKER CONFIGURATION, SPEAKER DISTANCE, SPEAKER CROSSOVER and CH LEVEL SETUP procedures.

SPEAKER/R . EQ SETUP	
> AUTO SETUP	
SPEAKER	CONFIG
SPEAKER	DISTANCE
SPEAKER	CROSSOVER
ROOM EQ	SETUP
RETURN TO MAIN MENU	

- AUTO SETUP : To set the speaker setup and channel level setup automatically.
- SPEAKER CONFIGURATION : To adjust the speakers depending on whether they are connected or not.
- SPEAKER DISTANCE: To select the distance between the listening position and each speaker to set the delay time automatically for optimum surround playback.
- SPEAKER CROSSOVER : To select the desired crossover frequency.
- ROOM EQ SETUP : To adjust the room EQ as desired.

When selecting the AUTO SETUP

- Auto Setup lets you avoid troublesome listening-based speaker setup and achieve good surround sound. Auto Setup has the feature that provides the optimum listening environment at the listening position in your room, where there are often multiple listeners viewing programs together. You should connect the supplied microphone to the SETUP MIC jack so that this receiver can analyze the information from a series of test tones emitted from speakers at the listening position and can adjust the configuration, distance, sound level, crossover frequency and frequency response of each speaker automatically.
- If you want to personalize your speaker setup and channel level setup by making the settings manually, perform the "When selecting the SPEAKER CONFIGURATION" on page 59, "When selecting the SPEAKER DISTANCE" on page 60, "When selecting the SPEAKER CROSSOVER" on page 61, "Adjusting each channel level with test tone" on page 35 and "Adjusting the current channel level" on page 36.
- After the auto setup has been completed, set the room EQ as desired. (For details, refer to "When selecting the ROOM EQ SETUP" on page 62.)

■ Preparations

- ①. Check that the speakers are securely connected to this receiver.
 - If your subwoofer has adjustable volume and crossover frequency, set the volume halfway and set the crossover frequency to the maximum or the low pass filter off.
- ②. Connect the supplied microphone to the SETUP MIC jack on the front panel.(For details, refer to "SETUP MIC JACK" on page 16.)

■ Notes :

- Because the microphone for Auto Setup is designed for use with this receiver, to use the auto setup function, do not use a microphone other than the one supplied with this receiver.
- After you have completed the auto setup procedure, disconnect the microphone.

1. Place the microphone on a flat level surface at the listening position.

- If possible, use a tripod, etc. to attach the microphone at the same height as your ears would be when you are seated in your listening position.
- Ensure there are no obstacles between the speakers and the microphone.

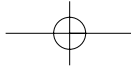

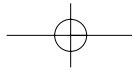

Continued

2. Press the CURSOR UP(▲)/DOWN(▼) buttons to select the AUTO SETUP, then press the ENTER button.

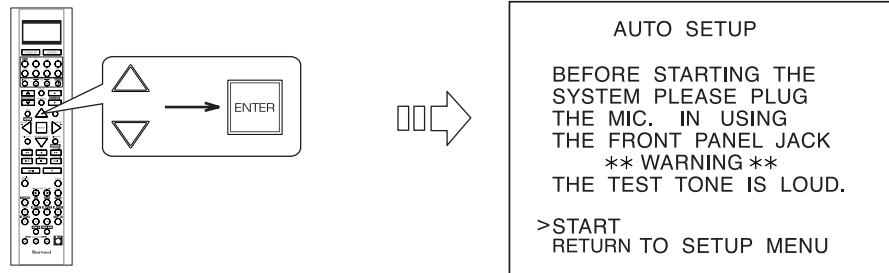

3. Press the CURSOR UP(▲)/DOWN(▼) buttons to select the START, then press the ENTER button.

When the auto setup has been completed.

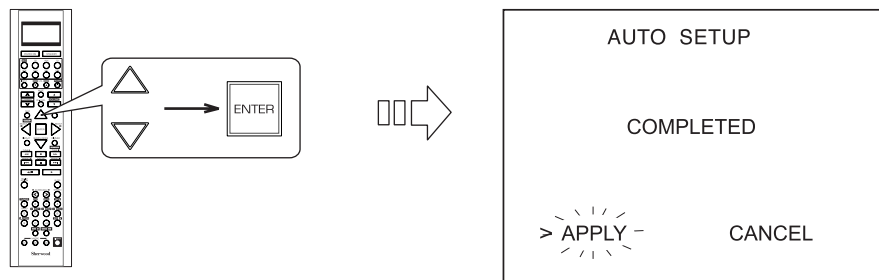

- Loud test tones are output successively and then if a series of auto setup procedure has been completed, "COMPLETED" will be displayed.
- To stop the auto setup procedure while performing it, press the ENTER button.
In such a case that the auto setup procedure is stopped before "COMPLETED" is displayed, the results of each adjustment may not be memorized.
- If there may be a problem with speaker or microphone connection, error message will be displayed. In this case, turn off the power, check the connection and then retry the auto setup procedure.

■ Notes :

- Before starting auto setup, be sure not to set the HDMI AUDIO OUT to ON.
- Because the test tones are loud, ensure there no infants or small children in the room.
- For best results, ensure the room is as quiet as possible during the auto setup procedure.
If there is too much ambient noise, the results may not be satisfactory.

4. To memorize the results, press the CURSOR LEFT(◀)/ RIGHT(▶) buttons to select the APPLY, then press the ENTER button.

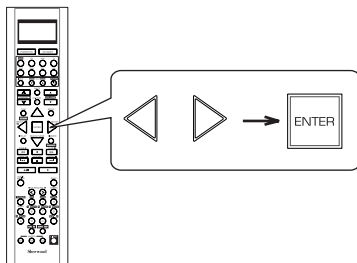

- Then the results are memorized and the SPEAKER/ ROOM EQ SETUP menu is displayed.
- Each time the CURSOR LEFT(◀)/ RIGHT(▶) buttons are pressed, the APPLY or the CANCEL is selected.
- When the CANCEL is selected, the results are not memorized.
- Check the results on each setup menu(SPEKER CONFIGURATION menu on page 59, SPEAKER DISTANCE menu on page 60, SPEAKER CROSSOVER menu on page 61 and CH LEVEL SETUP menu for "CALIBRATE" mode on page 64).
- If the results are not satisfactory, you can retry the auto setup procedure or personalize your speaker setup and channel level setup by making the settings manually. (For details, refer to "When selecting the SPEAKER CONFIGURATION" on page 59, "When selecting the SPEAKER DISTANCE" on page 60, "When selecting the SPEAKER CROSSOVER" on page 61, "Adjusting each channel level with test tone" on page 35 and "Adjusting the current channel level" on page 36.)

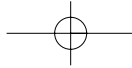

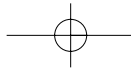

When selecting the SPEAKER CONFIGURATION

1. Press the CURSOR UP(▲)/DOWN(▼) buttons to select the SPEAKER CONFIGURATION, then press the ENTER button.

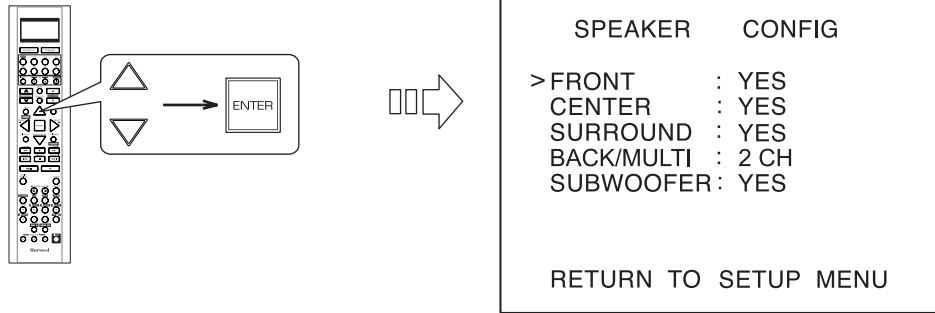

2. Press the CURSOR UP(▲)/DOWN(▼) buttons to select the desired speaker.

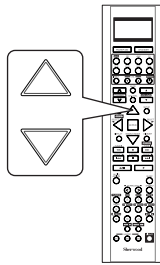

3. Press the CURSOR LEFT(◀)/RIGHT(▶) buttons to set the selected speaker as desired.

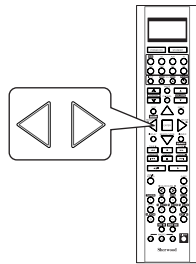

YES/NO: Select the desired depending on whether the speakers are connected or not.
 2CH/1CH: Select the desired depending on the number of speakers connected to SURROUND BACK/MULTI channels.

■ Notes :

- When speakers are not set to "NO", you should set their distances from listening position and crossover frequencies according to their frequency characteristics. (For details, refer to "When selecting the SPEAKER DISTANCE" on page 60 and "When selecting the SPEAKER CROSSOVER" on page 61.)
- When the "SURROUND" is set to "NO", "BACK/MULTI" cannot be set to "2CH" or "1CH".
- When the surround back channels' power amplifier is assigned to "BI-AMP" or "ROOM 2", the "BACK/MULTI" cannot be selected. (For details, refer to "When selecting the AMP ASSIGN" on page 49.)

4. Repeat the above steps 2 and 3 until the speakers are all set as desired.

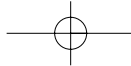

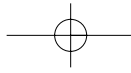

When selecting the SPEAKER DISTANCE

1. Press the CURSOR UP(▲)/DOWN(▼) buttons to select the SPEAKER DISTANCE, then press the ENTER button.

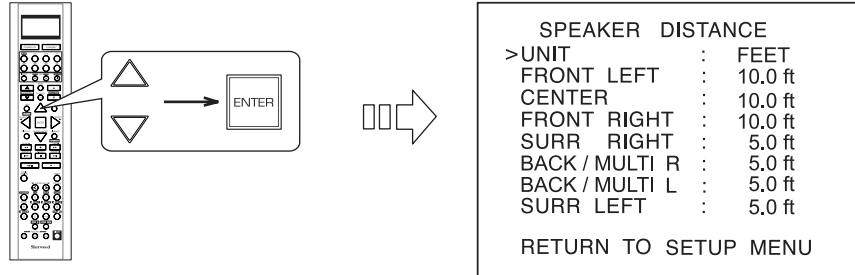

2. Press the CURSOR UP(▲)/DOWN(▼) buttons to select the desired item.

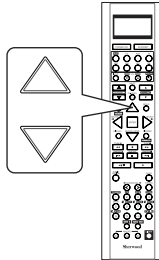

■ Note :

- You cannot select the subwoofer and the speakers set to "NO".

3. Press the CURSOR LEFT(◀)/RIGHT(▶) buttons to set the selected item as desired.

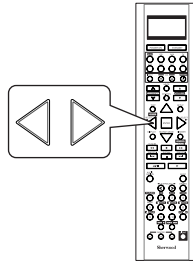

■ When selecting the desired unit

- You can select either METERS or FEET.
- Once a unit is selected, the distances are automatically changed in the selected unit.

■ When setting the distance

- You can set the distance within the range of 0.1 ~ 9.0 meters in 0.1 meter intervals (or 0.5 ~ 30 feet in 0.5 feet intervals).

4. Repeat the above steps 2 and 3 until the distances are all set as desired.

■ About the speaker distance

When enjoying multi-channel surround playback with Dolby Digital and DTS sources, etc., it is ideal that the center, surround and surround back speakers should be the same distance from the main listening position as the front speakers. By entering the distance between the listening position and each speaker, the delay times of center, surround and surround back speakers are automatically adjusted to create an ideal listening environment virtually as if the center, surround and surround back speakers were at their ideal locations respectively.

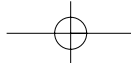

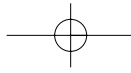

When selecting the SPEAKER CROSSOVER

- Set the crossover frequency according to the frequency characteristics of the speakers connected.
(For details on the frequency characteristics, refer to the operating instructions of the speakers.)
- If the frequency range of your speaker is 100 Hz ~ 20 kHz, the crossover frequency should be set to 100 Hz (or slightly higher).
- The low frequencies below the crossover frequency are to output from subwoofer or the speakers which are set to "FULL RANGE" (when not using a subwoofer).

1. Press the CURSOR UP(▲)/DOWN(▼) buttons to select the SPEAKER CROSSOVER, then press the ENTER button.

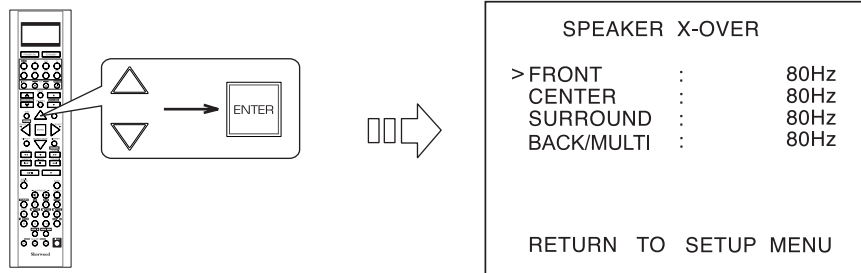

2. Press the CURSOR UP(▲)/DOWN(▼) buttons to select the desired speaker.

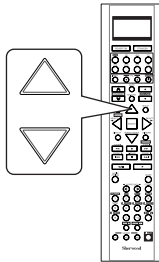

■ **Note :**

- You cannot select the subwoofer and the speakers set to "NO".

3. Press the CURSOR LEFT(◀)/RIGHT(▶) buttons to set the crossover frequency as desired.

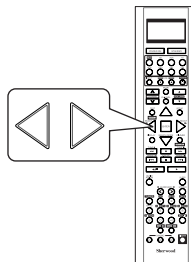

- You can adjust the crossover frequency within the range of 40 ~ 250 Hz.
- Select "FULL RANGE" when the selected speaker can fully reproduce the low frequencies below 40 Hz.

4. Repeat the above steps 2 and 3 until the crossover frequencies are all set as desired.

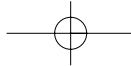

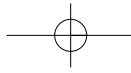

When selecting the ROOM EQ SETUP

- The room EQ is a kind of room equalizer for your speakers. According to the acoustic characteristics of your room measured by the auto setup, the room EQ automatically adjusts the frequency response of your speakers.
- If you use different brands or sizes of speakers for some channels or have a room with unique acoustic characteristics, such as walls, furniture, and the dimensions or the shape of the room, we recommend using the room EQ.

■ Note :

- To use the room EQ, first you should finish measuring the acoustic characteristics of your room performing the auto setup.
(For details, refer to "When selecting the AUTO SETUP" on page 57.)

1. Press the CURSOR UP(▲)/DOWN(▼) buttons to select the ROOM EQ SETUP, then press the ENTER button.

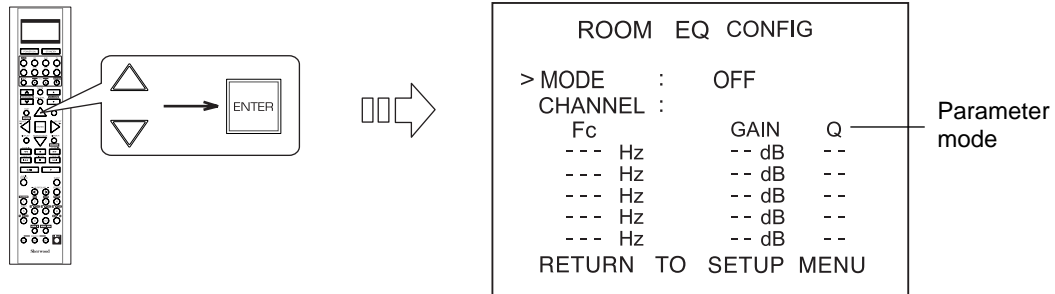

2. Press the CURSOR UP(▲)/DOWN(▼) buttons to select the MODE.

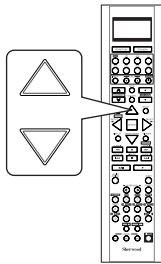

3. Press the CURSOR LEFT(◀)/RIGHT(▶) buttons to select the desired room EQ mode.

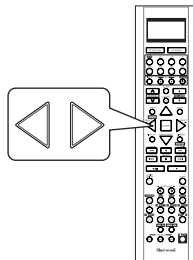

- OFF : When turning off the room EQ.
- ↕
- FLAT : To adjust the frequency response of all speakers to the flattest response. This mode is suitable for multi channel music surround sound sources.
- ↕
- FRONT : To adjust the frequency response of the surround and the surround back speakers to match the characteristics of the front speakers.
- ↕
- USER : To adjust the tonal quality of the different speakers (except the subwoofer) manually.

■ Note :

- Only when the auto setup has been performed, the FLAT and the FRONT modes can be selected.

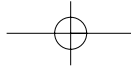

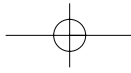
**Continued****■ When selecting the USER mode**

- You can adjust the parametric EQ settings to optimize the frequency characteristics of this unit's parametric equalizer to match the acoustic characteristics of your room.
- The parametric equalizer uses a combination of the following three parameters to provide highly precise adjustment of the frequency characteristics.

※ Frequency

- This unit has 5 equalizer bands for each channel. You can adjust the specified frequency bands each within the following frequency ranges :
20 Hz ~ 120 Hz, 130Hz ~ 500 Hz, 550 Hz ~ 1.9 kHz, 2 kHz ~ 7.5 kHz, 8 kHz ~ 20 kHz

※ Gain

- This parameter is adjustable within the range of -24 ~ +24 dB in 1 dB intervals.

※ Q factor

- The width of the specified frequency band is referred to as the Q factor. This parameter is adjustable within the range of 0 ~ 24 in 1 intervals.

■ Notes :

- When selecting the mode other than "USER" mode, you cannot select the EQ parameters for each channel.
- You cannot select the channel of the subwoofer and the speakers set to "NO".

- ①. Press the CURSOR UP(▲)/DOWN(▼) buttons to select the CHANNEL, then press the CURSOR LEFT(◀)/RIGHT(▶) buttons to select the desired channel.
- ②. Press the CURSOR UP(▲)/DOWN(▼) buttons to select the parameter mode, then press the CURSOR LEFT(◀)/RIGHT(▶) buttons to select the Fc (Frequency) mode.
- ③. Press the CURSOR UP(▲)/DOWN(▼) buttons to select the desired frequency band, then press the CURSOR LEFT(◀)/RIGHT(▶) buttons to select the desired frequency.
- ④. Repeat the above step ③ until the desired frequency is selected for each frequency band.
- ⑤. Repeat the above steps ② ~ ④ to adjust the gain of each specified frequency band.
- ⑥. Repeat the above steps ② ~ ④ to adjust the Q factor of each specified frequency band.
- ⑦. Repeat the above steps ① ~ ⑥ until the EQ parameters of other channels are all adjusted as desired.

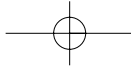

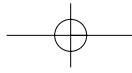

SETTING THE CH LEVEL SETUP

```

CH LEVEL SETUP
>MODE : CALIBRATE
FRONT LEFT : 0dB
CENTER : 0dB
FRONT RIGHT : 0dB
SURREIGHT : 0dB
BACK/MULTI R : 0dB
BACK/MULTI L : 0dB
SURRELEFT : 0dB
SUBWOOFER : 0dB
LFE LEVEL SETUP
RETURN TO MAIN MENU
  
```

Memory mode

■ **Note :**

- Depending on the speaker settings("NO", etc.), some channels cannot be selected.

Adjusting the current channel level

- You can adjust the current channel levels as desired. These adjusted levels are just memorized into user's memory("CALIBRATE"), not into preset memory("REFERENCE 1", "REFERENCE 2").
- After adjusting each channel level with test tone, adjust the channel levels either according to the program sources or to suit your tastes.(For details, refer to "Adjusting each channel level with test tone" on page 35.)

1. Press the CURSOR UP(▲)/DOWN(▼) buttons to select the desired channel.

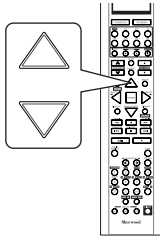

■ When adjusting the LFE LEVEL

- ①. Press the CURSOR UP(▲)/DOWN(▼) buttons to select the LFE LEVEL SETUP, then press the ENTER button.

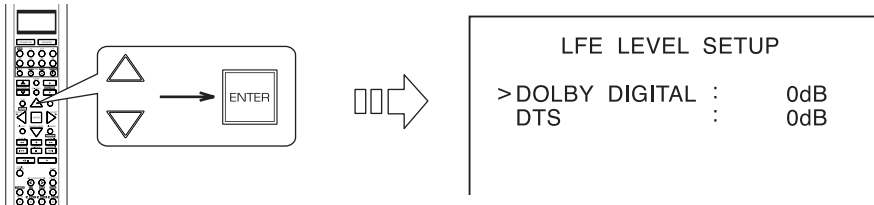

- ②. Press the CURSOR UP(▲)/DOWN(▼) buttons to select the desired program source.

2. Press the CURSOR LEFT(◀)/RIGHT(▶) buttons to adjust the level of the selected channel or program source's LFE as desired.

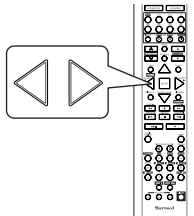

- The LFE level can be adjusted within the range of -10 ~ 0 dB and other channel levels within the range of -15 ~ +15 dB
- In general, we recommend the LFE level to be adjusted to 0 dB.(However, the recommended LFE level for some early DTS software is -10 dB.) If the recommended levels seem too high, lower setting as necessary.

3. Repeat the above steps 1 and 2 to adjust each channel level.

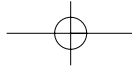

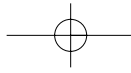

Memorizing the adjusted channel levels

- You can memorize the adjusted channel levels into preset memory("REFERENCE 1", "REFERENCE 2") and recall the memorized whenever you want.

- After performing the steps 1 ~ 3 in "Adjusting the current channel level" procedure on page 64, press the CURSOR UP(▲)/DOWN(▼) buttons to select a channel (, not the MODE (memory mode) and the LFE LEVEL SETUP), then press the ENTER button.

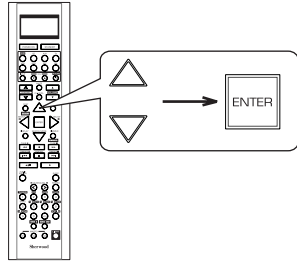

- The "REFERENCE 1" indication flickers.

- Press the CURSOR LEFT(◀)/RIGHT(▶) buttons to select the desired preset memory, then press the ENTER button.

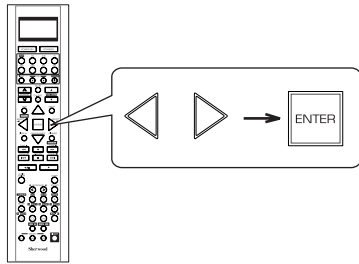

- Each time the CURSOR LEFT(◀) or RIGHT(▶) button is pressed, "REFERENCE 1" or "REFERENCE 2" is selected.
- The adjusted channel levels have now been memorized into the selected memory.

Recalling the memorized channel levels

- Press the CURSOR UP(▲)/DOWN(▼) buttons to select the MODE(memory mode).

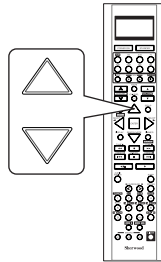

- "CALIBRATE" may be displayed instead of "REFERENCE 1" or "REFERENCE 2".

- Press the CURSOR LEFT(◀)/RIGHT(▶) buttons to select the desired one of REFERENCE 1 and REFERENCE 2.

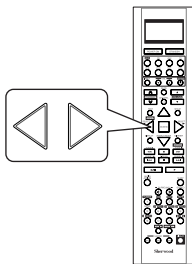

- Then the channel levels memorized into the selected preset memory are recalled.

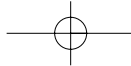

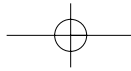

ENGLISH

SETTING THE SOUND PARAMETER

SOUND PARAMETER

- > NIGHT MODE
- DOLBY PLII MUSIC
- DOLBY HEADPHONE
- DOLBY VIRTUAL SPEAKER

RETURN TO MAIN MENU

- NIGHT MODE : To adjust the dynamic range compression that makes faint sound easier to hear at low volume levels.
- DOLBY PLII MUSIC : To adjust the various surround parameters for optimum surround effect.
- DOLBY HEADPHONE : To select the desired listening mode for Dolby Headphone mode.
- DOLBY VIRTUAL SPEAKER : To select the speaker layout to be used actually for each Dolby Virtual Speaker mode.

When selecting the NIGHT MODE

• This function compresses the dynamic range of previously specified parts of the Dolby Digital sound track (with extremely high volume) to minimize the difference in volume between the specified and non-specified parts.

This makes it easy to hear all of the sound track when watching movies at night at low levels.

■ Notes:

- The night mode setting is valid only when the digital signals from the Dolby Digital program source are being input.
- In some Dolby Digital softwares, the night mode setting may not be valid.

1. Press the CURSOR UP(▲)/DOWN(▼) buttons to select the NIGHT MODE, then press the ENTER button.

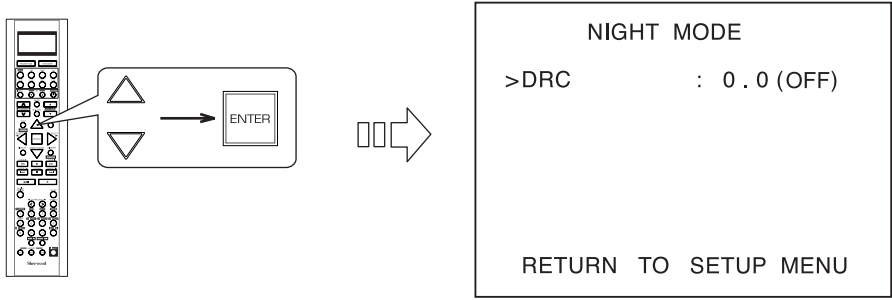

2. Press the CURSOR LEFT(◀)/RIGHT(▶) buttons to adjust the dynamic range compression as desired.

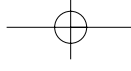
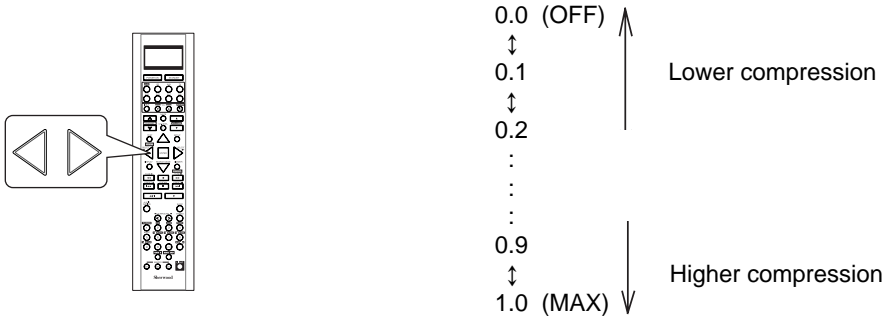

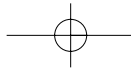

When selecting the DOLBY PLII MUSIC

- You can adjust the various surround parameters for optimum surround effect.

■ **Note:**

- The parameter settings are valid only when listening in either Dolby Pro Logic II Music mode or the Dolby Pro Logic IIx Music mode.

- Press the CURSOR UP(▲)/DOWN(▼) buttons to select the DOLBY PLII MUSIC, then press the ENTER button.

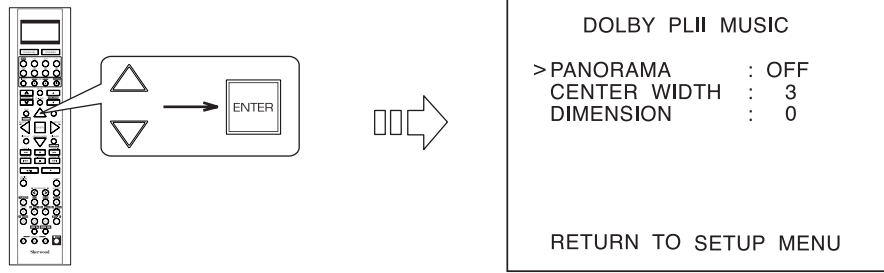

- Press the CURSOR UP(▲)/DOWN(▼) buttons to select the desired parameter.

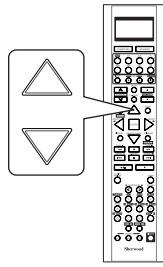

- Press the CURSOR LEFT(◀)/RIGHT(▶) buttons to adjust the selected parameter as desired.

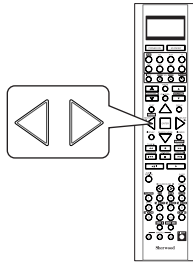

■ **When selecting the PANORAMA mode**

This mode extends the front stereo image to include the surround speakers for an exciting "wraparound" effect with side wall imaging. Select "OFF" or "ON"(default value:OFF).

■ **When selecting the CENTER WIDTH control**

This adjusts the center image so it may be heard only from the center speaker, only from the left/right speakers as a phantom image, or from all three front speakers to varying degrees. The control can be set in 8 steps from 0 to 7 (default value : 3).

■ **When selecting the DIMENSION control**

This gradually adjusts the soundfield either towards the front or towards the rear. The control can be set in 7 steps from -3 to +3(default value : 0).

- Repeat the above steps 2 and 3 to adjust other parameters.

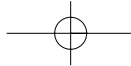

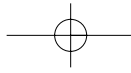

When selecting the DOLBY HEADPHONE

- You can select the desired listening mode for Dolby Headphone mode.

■ **Note:**

- The listening mode setting is valid only when playing analog stereo, PCM 2 channel or Dolby Digital 2 channel source.

- Press the CURSOR UP(▲)/DOWN(▼) buttons to select the DOLBY HEADPHONE, then press the ENTER button.

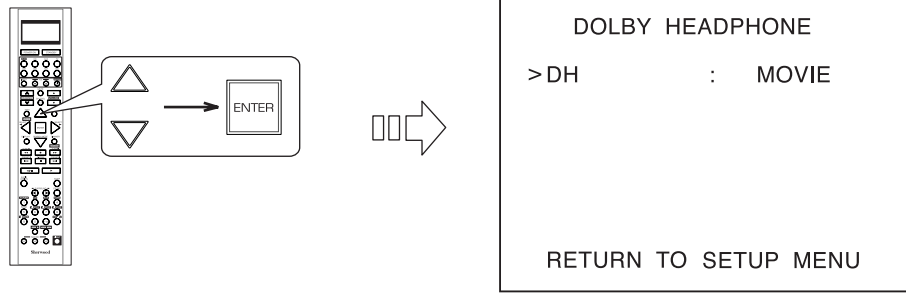

- Press the CURSOR LEFT(◀)/RIGHT(▶) buttons to select the desired listening mode.

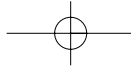
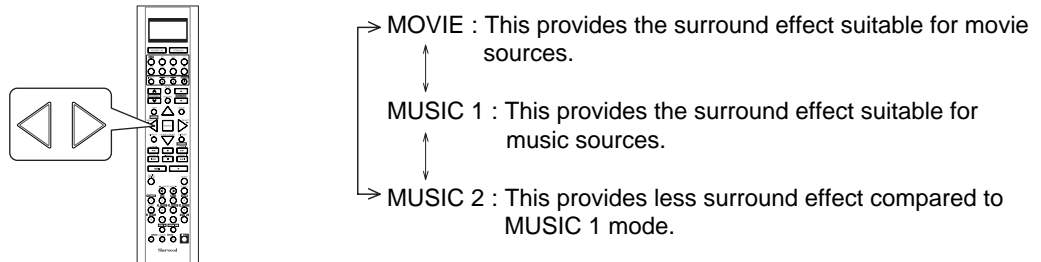

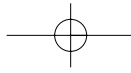

When selecting the DOLBY VIRTUAL SPEAKER

- You can select the speaker layout to be used actually for each Dolby Virtual Speaker mode.

■ **Note:**

- The speaker layout settings are valid only when listening in a Dolby Virtual Speaker mode.

1. Press the CURSOR UP(▲)/DOWN(▼) buttons to select the DOLBY VIRTUAL SPEAKER, then press the ENTER button.

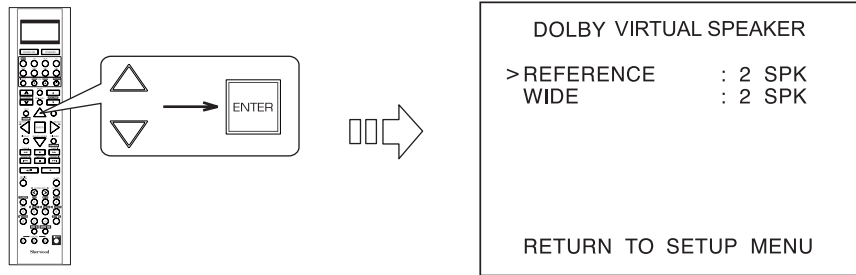

2. Press the CURSOR UP(▲)/DOWN(▼) buttons to select the desired Dolby Virtual Speaker mode.

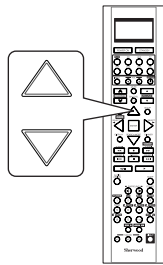

3. Press the CURSOR LEFT(◀)/RIGHT(▶) buttons to select the desired speaker layout.

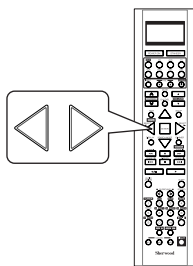

■ When selecting the Dolby Virtual Speaker Reference mode

2 SPK : When using 2 front speakers only.

3 SPK : When using 2 front and center speakers.

■ When selecting the Dolby Virtual Speaker Wide mode

2 SPK : When using 2 front speakers only.

3 SPK : When using 2 front and center speakers.

4 SPK : When using 2 front and 2 surround speakers.

5 SPK : When using 2 front, center and 2 surround speakers.

■ **Note:**

- When the speakers are set to "NO", the corresponding speaker layouts cannot be selected.

4. Repeat the above steps 2 and 3 to select the desired speaker layout for another Dolby Virtual Speaker mode.

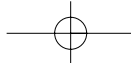

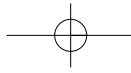

SETTING THE MULTI ROOM SETUP

- The ROOM 2 function allows enjoying one source in the main room while playing another in a different room at the same time.

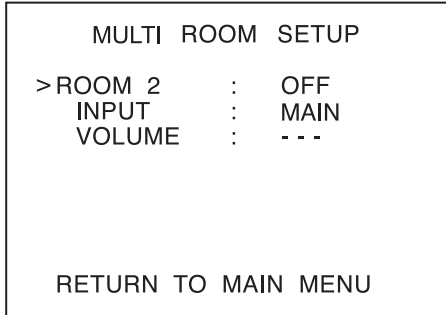

- ROOM 2 : To turn on or off the ROOM 2 function.
- INPUT : To select the desired ROOM 2 source.
- VOLUME : To adjust the volume on the power amplifier assigned to "BACK ← → ROOM 2" or "ROOM 2".

■ Notes:

- The analog signals from the EXTERNAL INs and the digital signals cannot be output to the different room, meaning no playback in a different room.
- You cannot play the ROOM 2 source in any surround mode.

- Press the CURSOR UP(▲)/DOWN(▼) buttons to select the desired item.

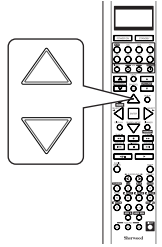

■ Note:

- The VOLUME cannot be adjusted when the AMP ASSIGN is assigned to "BI-AMP" or "SURR BACK". (For details, refer to "When selecting the AMP ASSIGN" on page 49.)

- Press the CURSOR LEFT(◀)/RIGHT(▶) buttons to set the selected item as desired.

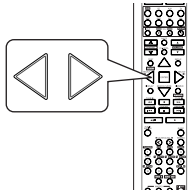

When selecting the ROOM 2

OFF : To turn off the ROOM 2 function.



ON : To turn it on.

■ Notes:

- When the ROOM 2 is set to OFF, the INPUT and the VOLUME cannot be selected.
- When you do not use the ROOM 2 function, set the ROOM 2 to OFF to save electricity.

When selecting the INPUT

- You can select the desired among MAIN source, TUNER, CD, AUX, TAPE, VIDEO 1 ~ VIDEO 4 as a ROOM 2 source.

■ Note:

- When the EXTERNAL IN is selected as a main input, if the MAIN source is selected as a ROOM 2 input, no audio signal can be heard in the different room (ROOM 2).

When selecting the VOLUME

- You can adjust the volume on the power amplifier assigned to "BACK ← → ROOM 2" or "ROOM 2" when the ROOM 2 speaker terminals are connected to the speakers in a different room.

■ Note:

- You can adjust the VOLUME only when the surround back channels' power amplifier is assigned to "BACK ← → ROOM 2" or "ROOM 2". (For details, refer to "When selecting the AMP ASSIGN" on page 49.)

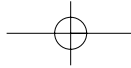

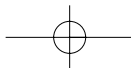

Troubleshooting Guide

If a fault occurs, run through the table below before taking your receiver for repair.

If the fault persists, attempt to solve it by switching the receiver off and on again. If this fails to resolve the situation, consult your dealer. Under no circumstances should you attempt to repair the receiver yourself. This could void the warranty.

PROBLEM	POSSIBLE CAUSE	REMEDY
No power	<ul style="list-style-type: none"> The AC input cord is disconnected. Poor connection at AC wall outlet or the outlet is dead or off. 	<ul style="list-style-type: none"> Connect cord securely. Check the outlet using a lamp or another appliance.
No sound	<ul style="list-style-type: none"> The speaker wires are disconnected. The master volume is adjusted too low. The MUTE button is pressed to ON. Incorrect selection of input source. Incorrect connections between the components. The HDMI AUDIO OUT is set to ON. <ul style="list-style-type: none"> The settings related to audio are set incorrectly. 	<ul style="list-style-type: none"> Check the speaker connections. Adjust the master volume. Press the MUTE button to cancel the muting effect. Select the desired input source correctly. Make connections correctly. Set it to OFF. (For details, refer to "When selecting the HDMI AUDIO OUT" on page 50.) Set the settings correctly. (For details, refer to "SETTING THE INPUT SETUP" on page 53.)
No sound from the surround speakers	<ul style="list-style-type: none"> Surround mode is switched off(stereo mode). Master volume and surround level are too low. Monaural source is used. Surround speaker setting is "NO". 	<ul style="list-style-type: none"> Select a surround mode. Adjust master volume and surround level. Select a stereo or surround source. Select the desired surround speaker setting.
No sound from the center speaker	<ul style="list-style-type: none"> Dolby Virtual Speaker, stereo mode, etc is selected. Center speaker setting is "NO". Master volume and center level are too low. 	<ul style="list-style-type: none"> Select the desired surround mode. Select the desired center speaker setting. Adjust master volume and center level.
No sound from the surround back speakers	<ul style="list-style-type: none"> The input signal format or the current surround mode cannot support the 7.1(or 6.1) surround. The surround back channels' power amplifier is assigned to "BI-AMP" or "ROOM 2". Master volume and surround back level are too low. Surround back speaker setting is "NO". 	<ul style="list-style-type: none"> Under the proper situations, perform the 7.1(or 6.1) surround playback.(For details, refer to "ENJOYING SURROUND SOUND" on page 34.) Assign the power amplifier to the surround back channels.(For details, refer to "When selecting the AMP ASSIGN"on page 49.) Adjust master volume and surround back level. Select the desired surround back speaker setting.
No picture	<ul style="list-style-type: none"> Video connections between this unit and the monitor TV are not made correctly. Incorrect selection of input source on the monitor TV. The settings related to video are set incorrectly. 	<ul style="list-style-type: none"> Make proper video connections. Select the input source correctly. Set the settings correctly. (For details, refer to "SETTING THE INPUT SETUP" on page 53.)
No picture with an HDMI connection	<ul style="list-style-type: none"> HDMI connection between this unit and the monitor TV are not made correctly. The monitor TV or other equipments do not support HDCP. 	<ul style="list-style-type: none"> Make proper HDMI connection. This unit will not output video signal unless the connected equipments supports HDCP.
Stations cannot be received	<ul style="list-style-type: none"> No antenna is connected. The desired station frequency is not tuned in. Antenna is in wrong position. 	<ul style="list-style-type: none"> Connect an antenna. Tune in the desired station frequency. Move antenna and retry tuning.
Preset stations cannot be received	<ul style="list-style-type: none"> An incorrect station frequency has been memorized. The memorized stations are cleared. 	<ul style="list-style-type: none"> Memorize the correct station frequency. Memorize the stations again.
Poor FM reception	<ul style="list-style-type: none"> No antenna is connected. The antenna is not positioned for the best reception. Weak signals. 	<ul style="list-style-type: none"> Connect an antenna. Change the position of the antenna. Install an outdoor FM antenna.
Continuous or intermittent hissing noise during AM reception, especially at night.	<ul style="list-style-type: none"> Noise is caused by motors, fluorescent lamps or lightning, etc. 	<ul style="list-style-type: none"> Keep the receiver away from noise sources. Install an outdoor AM antenna.
Remote control unit does not operate.	<ul style="list-style-type: none"> Batteries are not loaded or exhausted. The remote sensor is obstructed. 	<ul style="list-style-type: none"> Replace the batteries. Remove the obstacle.
OSD function is not available.	<ul style="list-style-type: none"> Video connections between this unit and the monitor TV are not made correctly. 	<ul style="list-style-type: none"> Make proper video connections.

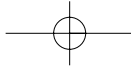

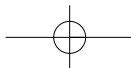

Specifications

ENGLISH

■ AMPLIFIER SECTION

- Power output, stereo mode, 6 Ω , THD 1.0 %, 40 Hz~20 kHz | **2 x 100 W**
- Total harmonic distortion, at -3 dB, 6 Ω , 1 kHz | **0.05%**
- Intermodulation distortion
60 Hz : 7 kHz= 4 : 1 SMPTE, 6 Ω , 95 W | **0.05%**
- Input sensitivity/impedance
Line (CD, TAPE, VIDEO) | **300 mV/47k Ω**
- Signal to noise ratio, IHF "A" weighted
Line (CD, TAPE, VIDEO) | **100 dB**
- Frequency response
Line (CD, TAPE, VIDEO), 10 Hz ~ 100 kHz | **+0, -3 dB**
- Output level
ROOM 2 OUT, 2.2 k Ω | **300 mV**
- Bass/Treble control, 100 Hz/10 kHz | **± 10 dB**
- Surround mode, only channel driven
Front power output, 6 Ω , 1 kHz, THD 1.0 % | **110W / 110 W**
Center power output, 6 Ω , 1 kHz, THD 1.0 % | **110 W**
Surround power output, 6 Ω , 1 kHz, THD 1.0 % | **110 W / 110W**
Surround back (/MULTI) / ROOM 2 power output, 6 Ω , 1 kHz, THD 1.0 % | **110 W / 110W**

■ DIGITAL AUDIO SECTION

- Sampling frequency | **32, 44.1, 48, 96 kHz**
- Digital input level
Coaxial, 75 Ω | **0.5 Vp-p**
Optical, 660 nm | **-15 ~ -21 dBm**

■ VIDEO SECTION

- Video format | **NTSC**
- Input sensitivity(=Output level), 75 Ω
Video (Composite(normal)) | **1 Vp-p**
S-Video (luminance signal) | **1 Vp-p**
(chrominance signal) | **0.286 Vp-p**
Component video (R-Y signal) | **0.5 Vp-p**
(B-Y signal) | **0.5 Vp-p**
(Y signal) | **1.0 Vp-p**
- HDMI connector | **19 pin**

■ FM TUNER SECTION

- Tuning frequency range | **87.5~108 MHz**
- Usable sensitivity, THD 3%, S/N 30 dB | **12.8 dBf**
- 50 dB quieting sensitivity, mono/stereo | **20.2 / 45.3 dBf**
- Signal to noise ratio, 65 dBf, mono/stereo | **70 / 65 dB**
- Total harmonic distortion, 65 dBf, 1 kHz, mono/stereo | **0.5 / 0.8 %**
- Frequency response, 30 Hz~15 kHz | **± 3 dB**
- Stereo separation, 1 kHz | **32 dB**
- Capture ratio | **4.0 dB**
- IF rejection ratio | **60 dB**

■ AM TUNER SECTION

- Tuning frequency range | **520~1710 kHz**
- Usable sensitivity | **500 μ V/m**
- Signal to noise ratio | **40 dB**
- Selectivity | **25 dB**

■ GENERAL

- Power supply | **120 V ~ 60 Hz**
- Power consumption | **3.7 A**
- Switched AC outlets | **TOTAL 120 W (1 A) max.**
- Dimensions (W x H x D, including protruding parts) | **440 x 141 x 370 mm (17-3/8 x 5-1/2 x 14-1/2 inches)**
- Weight (Net) | **10.1 kg (22.3 lbs)**

Note: Design and specifications are subject to change without notice for improvements.

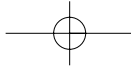

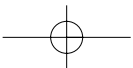

ENGLISH

Pilot	005	003	006			
Pioneer	022					
Portland	003	006	014			
Prism	008					
Proscan	007					
Proton	025	032				
Pulsar	002	003				
Quasar	008	042	021			
RCA	007	008	041	003	013	015
	037	038	039	040		
Radio Shack	007	019	021	027	005	025
	003	011	006			
Realistic	019	021	027	005	025	003
	011	006				
Runco	002	005	033			
SSS	027	003				
Sampo	005	006				
Samsung	012	005	025	003	011	045
Samsux	006					
Sansei	030					
Sansui	031					
Sanyo	019					
Scimitsu	003					
Scotch	025					
Scott	028	027	025	003	026	
Sears	007	010	019	020	025	026
	011	006				
Semivox	027					
Semp	020					
Sharp	041	021	006			
Sherwood	000					
Shogun	003					
Signature	001					
Sony	050					
Soundesign	027	025	026			
Squareview	023					
Starlite	027					
Supreme	050					
Sylvania	010	005				
Symphonic	023					
TMK	025	011	024			
Tandy	041					
Technics	008	042				
Technoi Ace	026					
Techwood	008	011				
Tekn ka	010	027	017	012	003	026
	011	001	006	014		
Telefunken	011					
Tosh ba	019	020	012			
Totevision	006					
Vector Research	005					
Victor	009					
Vidikron	010					

Vidtech	025	003				
Wards	010	021	005	025	004	003
	026	011	001			
White Westinghouse	031	034	035			
Yamaha	005	003				
Zenith	002	031	001	014		

VCR

Admiral	027	021				
Adventura	000					
Aiko	025					
Aiwa	005	000				
Akai	026					
America Action	025					
America High	004					
Asha	023					
Audiovox	005					
Beaumarck	023					
Bell & Howell	017					
Brocksonic	021					
Broksonic	020	018	021	001		
CCE	015	025				
Calix	005					
Canon	004					
Carver	081					
Cineral	025					
Citizen	005	025				
Colt	015					
Craig	005	012	023	015	024	
Curtis Mathes	013	004	026	028		
Cybernex	023					
Daewoo	010	025				
Denon	008					
Dynatech	000					
Electrohome	005					
Electroponic	005					
Emerex	002					
Emerson	005	020	000	018	009	021
	001	025				
Fisher	012	017				
Fuji	004	003				
Funai	000					
GE	013	004	027	023		
Garrard	000					
Go Video	052					
GoldStar	005	006				
Gradiente	000					
HI-Q	012					
Harley Davidson	000					
Harman/Kardon	016	006				
Harwood	015					

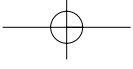

Headquarter	011
Hitachi	000 008 026
Hughes Net.Sys	008
JVC	014 026
Jensen	026
KEC	005 025
KLH	015
Kenwood	014 026 006
Kodak	004 005
LXI	005
Lloyd's	000
Logik	015
MEI	004
MGA	023 009
MGN Technology	023
MTC	023 000
Magnasonic	025
Magnavox	004 007 016 000 019
Magnin	023
Marantz	004 016
Marta	005
Matsushita	004 028 029
Memorex	004 005 027 007 012 023 000 017 021 011 031 032
Minolta	008
Mitsubishi	027 014 009
Motorola	004 027
Multitech	000 015
NEC	017 014 026 006
Nikko	005
Noblex	023
Olympus	004
Opimus	005 027 017 028 029 030 031 032
Orion	020 021 001
Panasonic	004 028 022 029 031
Penny	004 005 023 008 006
Pentax	008
Philco	004 021
Philips	004 016
Pilot	005
Pioneer	014
Profitronic	023
Proscan	013
Protec	015
Pulsar	007
Quarter	011
Quartz	011
Quasar	004 028 029 031
RCA	013 004 027 023 008 019
Radio Shack	000
Radix	005
Randex	005

Realistic	004 005 027 012 000 017 011
Runco	007
STS	008
Samsung	023 010 033
Sanky	027 007
Sansui	000 014 021 026 024
Sanyo	012 023 017 011
Scott	020 010 018 009
Sears	004 005 012 000 008 017 011
Semp	010
Sharp	027
Shintom	015
Shogun	023
Singer	015
Sony	004 002 000 003
Sylvania	004 016 000 009
Symphonic	000
TMK	023
Tatung	026
Teac	000 026
Technics	004 028
Tekn ka	004 005 000
Thomas	000
Tosh ba	010 009
Totevision	005 023
Unitech	023
Vector	010
Vector Research	006
Video Concepts	010
Videosonic	023
Wards	013 004 027 012 016 023 000 008 015 019
White WestingHouse	021 025
XR-100	004 000 015
Yamaha	006
Zenith	007 000 021 003
Ameira High	004 (TV use 008)
Brocksonic	001
Colt	015
Cutis Mathes	004 (TV use 008)
Daewoo	025
Emerson	001
Funai	000
GE	004 (TV use 008) 013 (TV use 012) 027 (TV use 041) 023
Hitachi	004 (TV use 008) 000
HQ	000
Lloyds	000
MGA	023
Megavox	016 (TV use 010) 004 (TV use 008) 000

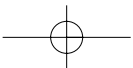

ENGLISH

Magnin	023
Memorex	005 028 (TV use 025)
Mitsubishi	027 (TV use 041)
Orion	001
Panasonic	004 (TV use 008) 028 (TV use 042)
Penney	004 (TV use 008) 023 028 (TV use 042)
Quasar	004 (TV use 008) 028 (TV use 042)
RCA	013 (TV use 012) 004 (TV use 008) 027 (TV use 041)
Sansui	000
Sanyo	023
Sear	000 005
Sharp	027 (TV use 041)
Sony	002 (TV use 000)
Symphonic	000
Zenith	000

DVD

Harman/Kardon	009
JVC	008
Kenwood	005
Megavox	011
Mitsubishi	016
Onkyo	011
Panasonic	013
Philips	011 006
Pioneer	003 014 026
Proscan	002
RCA	002
Samsung	017
Sherwood	001 012 000 018 019 020 021 022 023 025
Sony	004
Technics	013
Theta Digital	014
Tosh ba	011
Yamaha	013 007
Zenith	011 010

CBL

ABC	002 003 009 030 007 006 008
Allegro	018 021
Archer	018 026
Bell&Howell	009
Century	018
Citizen	018 021
Comtronics	014
Contec	011
Easten	001
Emerson	026
Everquest	010 014
Focus	022
Garrard	018
Gemini	010
General Instrument	033 276 006 034
GoldStar	017 040
Goodmind	026
Hamlin	012 020 004 013
Hitachi	006
Hytex	007
Jasco	010 018 021
Jerrold	002 007 033 032 009 010 006 034
Movie Time	015
NSC	015
Oak	011
Optimus	031
Panasonic	016 031
Philips	018
Pioneer	017 025
Popular Mechanics	022
RCA	031
Radio Shack	010 021 026 028
Recoton	022
Regal	012 020
Regency	001
Rembrandt	006
Sherwood	000
SL Marx	014
Smasung	017 014
Scientific Atlanta	003 023 030 027
Signal	010 014
Signature	006
Sprucer	031
Starcom	002 010

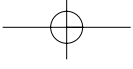

Stargate	010	014	026
Starquest	010		
TV86	015		
Televue	014		
Tocom	007	008	
Tusa	010		
Unika	018		
United Artists	007		
Universal	153	019	
Viewstar	015		
Zenith	024		
Zentek	022		

AUX-LD

Denon	007		
Mitsubishi	007		
NAD	007		
Pioneer	007		
Sony	017	018	

ENGLISH

SAT

AlphaStar	008		
Chaparral	001		
Echostar	009		
Expreevu	009		
General Instrument	016	015	018
HTS	009		
Hitachi	011		
Hughes Net.Sys	007		
JVC	009		
Jerrold	016	015	
Megavox	006	005	
Memorex	006		
Next Level	006		
Panasonic	017		
Philips	006	005	
Primestar	016	015	
RCA	003	002	012
Radio Shack	018		
Realistic	014		
Sherwood	000		
Sony	004		
Star Choice	018		
Toshiba	010		
Uniden	006	005	014
Zenith	013		

AUX-TAPE

Aiwa	004	034	
Carver	004		
Harman/Kardon	016	004	
JVC	022	024	
Kenwood	008		
Megavox	004		
Marantz	004		
Onkyo	012	025	
Opimus	002	020	
Panasonic	038		
Pioneer	002	020	011
Sansui	004		
Sony	021	014	026
Technics	038		
Victor	024		
Wards	002		
Yamaha	010	009	

AUX-TAPE/MD

Sherwood	000 (for tape deck)		
	035 (for MD recorder)		

AUX-AMP

Aiwa	029		
Carver	023		
Curtis Mathes	027		
Denon	037		
Harman/Kardon	040		
Linn	023		
Megavox	023		
Marantz	023		
Panasonic	039		
Philips	023	040	
Pioneer	003	027	
Sony	019	033	
Technics	039		
Wards	003		
Yamaha	028		

ENGLISH

AUX-HOME AUTOMATION

GE	043
Lutron	044
One For All	042
Radio Shack	043
Security System	042
Universal X10	042
X10	042

AUX-DBS

Aiwa	045	059	029
Fisher	005		
Harman/Kardon	046		
JBL	046		
JVC	047		
Jerrold	031		
RCA	006		
Scientific Atlanta	032		
Sony	045		
Starcom	031		

AUX-ACCESSARY

Archer	013
GC Electronics	013
Jebsee	013
Rabbit	036
Radio Shack	013

CD

Aiwa	010	030
Burmester	019	
California Audio Lab	002	
Carver	010	012 020
DKK	001	
Denon	028	034
Emerson	035	
Fisher	012	033
Garrard	019	018
Genexxa	004	035
Harman/Kardon	010	011
Hitachi	004	
JVC	007	

Kenwood	003	029	016	024	025
Krell	010				
LXI	035				
Linn	010				
MCS	002				
MTC	019				
Megavox	010	035			
Marantz	002	010	013		
Mission	010				
NSM	010				
Nikko	033				
Onkyo	008	026			
Opimus	001	004	012	035	029
	019	009	021	020	
Panasonic	002	031			
Parasound	019				
Philips	010	023			
Pioneer	004	035	021	017	
Proton	010				
QED	010				
Quasar	002				
RCA	012	035	006	036	
Realistic	012	019	013		
Rotel	010	019			
SAE	010				
Sansui	010	035			
Sanyo	012				
Scott	035				
Sears	035				
Sharp	029	013	037		
Sherwood	013	027	038	039	040 041
	000				
Sony	001	014	022		
Soundesign	009				
Tascam	019				
Teac	019	018	033	013	
Technics	002	031			
Victor	007				
Wards	010	006			
Yamaha	005	015			
Yorx	032				

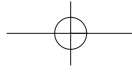

R-772

Audio/Video Receiver

